

## History and concept

SJOC Retail was founded in Holbæk, Denmark in 1999 and is owned by Christian Holm Schønbeck and Jan Søndergård.

The concept of SJOC Retail is to supply quality lighting fixtures to affordable prices to the European retail market as well as delivering a unique customer service.

To find out more about SJOC Retail and our newest products please visit our website at:

[www.sjoc.dk](http://www.sjoc.dk)

Enjoy our new catalogue



Christian Holm Schønbeck  
CEO / Owner

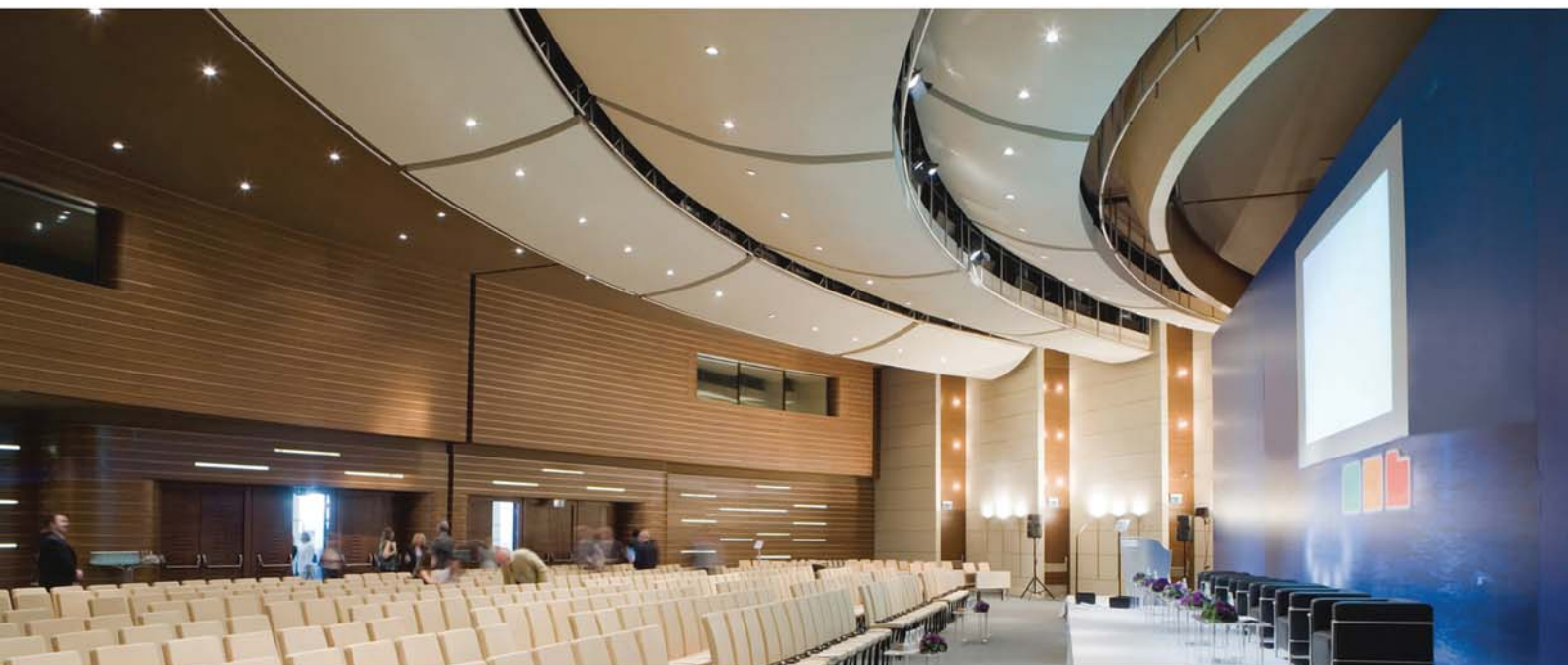

**STYLE THE LIGHT YOUR WAY**













YOUR CHOICE - ASSEMBLED IN DENMARK - RECYCLE

No store or location is the same, and therefore the lighting requirements vary greatly.

You style the light **your way** by choosing how many Watt, Lumen, Kelvin, Ra value and what beam angle you want out of your lamp.

We assemble your products in Denmark. We can rebuild your old lamp with the newest generation and technology of LED.

In this way you are a part of our recycling system.

|  |   |                 |
|--|---|-----------------|
| <b>Tracklights</b>                               |    | <b>Page 2</b>   |
| <b>3-circuit track</b>                           |    | <b>Page 44</b>  |
| <b>Downlights</b>                                |    | <b>Page 48</b>  |
| <b>Panel</b>                                     |    | <b>Page 71</b>  |
| <b>Pendants</b>                                  |    | <b>Page 85</b>  |
| <b>Office light</b>                              |   | <b>Page 98</b>  |
| <b>Ceiling/Wall light</b>                        |  | <b>Page 108</b> |
| <b>Industrial lighting/<br/>Outdoor lighting</b> |  | <b>Page 119</b> |
| <b>Trunk</b>                                     |  | <b>Page 147</b> |
| <b>Slim track/<br/>Cabinet lighting</b>          |  | <b>Page 150</b> |
| <b>Light source</b>                              |  | <b>Page 164</b> |
| <b>Logo light</b>                                |  | <b>Page 169</b> |



### Calypso Mini

Lumen output  
Max. 3500 Lm

Page 6



### Janus

Lumen output  
Max. 4500 Lm

Page 15



### Calypso

Lumen output  
Max. 4500 Lm

Page 7



### Methone

Lumen output  
Max. 3500 Lm

Page 17



### Calypso Midi

Lumen output  
Max. 5000 Lm

Page 8



### Leda 2

Lumen output  
Max. 4500 Lm

Page 18



### Calypso Pro

Lumen output  
Max. 3150 Lm

Page 10



### Pollux

Lumen output  
Max. 3600 Lm

Page 19



### Calypso Pin

Lumen output  
Max. 2000 Lm

Page 11



### Deimos

Lumen output  
Max. 700 Lm

Page 21



### Dione Micro

Lumen output  
Max. 3000 Lm

Page 12



### Mars GU10

Lumen output  
Max. 1000 Lm

Page 22



### Dione Mini

Lumen output  
Max. 5000 Lm

Page 13



**Sirius**

Lumen output  
Max. 4800 Lm

Page 23



**Triton Micro**

Lumen output  
Max. 3000 Lm

Page 24



**Triton Mini**

Lumen output  
Max. 4000 Lm

Page 26



**Triton**

Lumen output  
Max. 5000 Lm

Page 27



**Moon Tracklight**

Lumen output  
Max. 2400 Lm

Page 28



**Linear Light**

Lumen output  
Max. 3.900 Lm

Page 29



**Flat Panel**

Lumen output  
Max. 10.240 Lm

Page 31

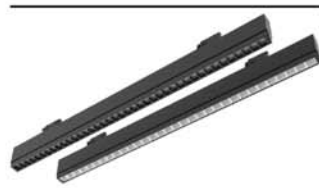

**Gamma**

Lumen output  
Max. 3000 Lm

Page 32

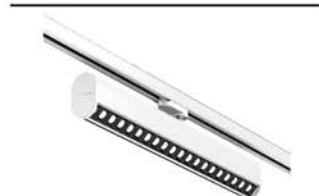

**Pandia**

Lumen output  
Max. 11200 Lm

Page 33



**Dia**

Lumen output  
Max. 2100 Lm

Page 34



**Bricks Adjustable**

Lumen output  
Max. 7020 Lm

Page 35



**Bricks Angel Wings**

Lumen output  
Max. 6000 Lm

Page 37



**Bricks Rotateable**

Lumen output  
Max. 7200 Lm

Page 38



# Tracklights



## Bricks Linear A

Lumen output  
Max. 10800 Lm

Page 39



## 3-Circuit Tracks

Page 44



## Bricks Linear D

Lumen output  
Max. 8400 Lm

Page 40



## 3-Circuit Track Accessories

Page 45



## Bricks Track Line

Lumen output  
Max. 9100 Lm

Page 41



## 3-Circuit Tracks DALI

Page 46



## Bricks Deep

Lumen output  
Max. 7000 Lm

Page 42



## 3-Circuit Track Accessories DALI

Page 47



LED





# Calypso Mini

## DESCRIPTION

Spotlight for track system with incorporated electronic gear.

Housing made of die cast aluminium.

Easy to change.

Philips SLM slim system allow to produce fixture of homogenous lighting performance and high-efficiency natural looking light. Also with using high efficiency reflector, it can be performed in various beam angles.

Driver: Philips

Certificates: CE/ETL/CCC

Beam angle 15°/24°/36°

Colors: White/black/silver



LED TRACKLIGHT

|            |                         |           |        |                            |                  |              |                 |
|------------|-------------------------|-----------|--------|----------------------------|------------------|--------------|-----------------|
| <b>LED</b> | <b>5 YEARS WARRANTY</b> | <b>CE</b> | 50000h | <b>L 70</b><br><b>B 50</b> | <b>MacAdam 3</b> | <b>IP 20</b> | <b>Hg 0.0mg</b> |
|            |                         |           |        |                            |                  | >100000      | ≤1S             |

## PHOTOMETRIC CURVE

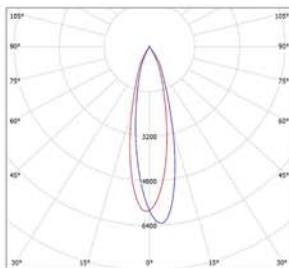

## AREA OF USE

Display windows, shops and other public places

## CAN BE DELIVERED WITH:

- 2700K
- 4000K
- 5000K
- Food COB
- Meat COB



| TYPE  | CRI    | LIGHT OUT | POWER | COLOR TEMP |
|-------|--------|-----------|-------|------------|
| 10100 | >80 Ra | 2000 lm   | 11 W  | 3000K      |
| 10100 | >80 Ra | 3000 lm   | 20 W  | 3000K      |
| 10100 | >80 Ra | 3500 lm   | 24 W  | 3000K      |



## DESCRIPTION

Spotlight for track system with incorporated electronic gear.

Housing made of die cast aluminium.

Easy to change.

Philips SLM slim system allow to produce fixture of homogeneous lighting performance and high-efficiency natural looking light.

Driver: Philips

Beam angle 12°/24°/36°/50°

Certificates: CE/ETL/CCC

Colors: White/black/silver



## PHOTOMETRIC CURVE

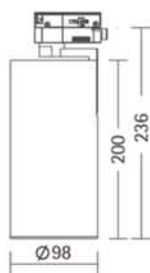
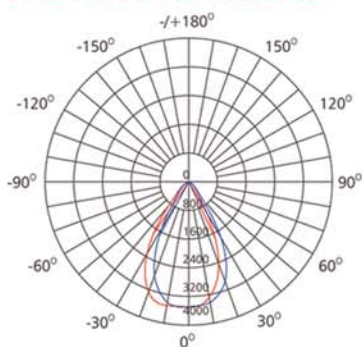

## AREA OF USE

Display windows, shops and other public places

## CAN BE DELIVERED WITH:

- 2700K
- 4000K
- 5000K
- Food COB
- Meat COB

| TYPE  | CRI    | LIGHT OUT | POWER | COLOR TEMP |
|-------|--------|-----------|-------|------------|
| 10300 | >80 Ra | 2000 lm   | 11 W  | 3000K      |
| 10300 | >80 Ra | 3000 lm   | 20 W  | 3000K      |
| 10300 | >80 Ra | 3500 lm   | 24 W  | 3000K      |
| 10300 | >80 Ra | 4000 lm   | 27 W  | 3000K      |
| 10300 | >90 Ra | 2000 lm   | 16 W  | 3000K      |
| 10300 | >90 Ra | 3000 lm   | 24 W  | 3000K      |
| 10300 | >90 Ra | 3500 lm   | 27 W  | 3000K      |



# Calypso Midi

## DESCRIPTION

Spotlight for track system with incorporated electronic gear.

Housing made of die cast aluminium.

Easy to change.

Philips SLM slim system allow to produce fixture of homogenous lighting performance and high-efficiency natural looking light.

Driver: Philips

Beam angle 12°/24°/36°/50°

Certificates: CE/ETL/CCC

Colors: White/black/silver



LED TRACKLIGHT

|            |                         |           |        |                  |                  |              |                 |
|------------|-------------------------|-----------|--------|------------------|------------------|--------------|-----------------|
| <b>LED</b> | <b>5 YEARS WARRANTY</b> | <b>CE</b> | 50000h | <b>L 70 B 50</b> | <b>MacAdam 3</b> | <b>IP 20</b> | <b>Hg 0.0mg</b> |
|            |                         |           |        |                  |                  |              |                 |

## PHOTOMETRIC CURVE

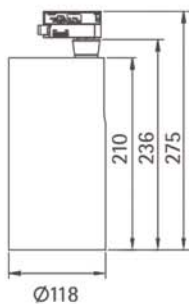
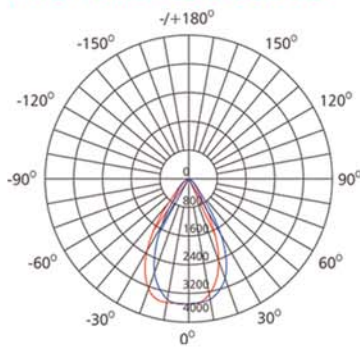

## AREA OF USE

Display windows, shops and other public places

## CAN BE DELIVERED WITH:

- 2700K
- 4000K
- 5000K
- Food COB
- Meat COB

| TYPE  | CRI    | LIGHT OUT | POWER | COLOR TEMP |
|-------|--------|-----------|-------|------------|
| 10200 | >80 Ra | 3000 lm   | 20 W  | 3000K      |
| 10200 | >80 Ra | 3500 lm   | 24 W  | 3000K      |
| 10200 | >80 Ra | 4000 lm   | 27 W  | 3000K      |
| 10200 | >80 Ra | 4500 lm   | 31 W  | 3000K      |
| 10200 | >80 Ra | 5000 lm   | 37 W  | 3000K      |
| 10200 | >90 Ra | 3000 lm   | 24 W  | 3000K      |
| 10200 | >90 Ra | 3500 lm   | 27 W  | 3000K      |
| 10200 | >90 Ra | 4000 lm   | 31 W  | 3000K      |
| 10200 | >90 Ra | 4500 lm   | 37 W  | 3000K      |





# Calypso Pro

LED TRACKLIGHT

**DESCRIPTION**

Spotlight for track system with incorporated electronic gear or surface mount.

Color adjustable: change between different temperatures of white light.

Adjustable beam angle from 10° to 60°

ZOOM

Light efficiency: 95-105 Lm/W

Certificates: CE/TÜV/RoHS

Honeycomb is not standard delivery

Colors: White/black



**AREA OF USE**

Display windows, shops and other public places



**DELIVERED WITH:**

Adjustable CCT 3000K, 4000K, 5700K

0-10V Dim

ZOOM

|       | A  | B   |
|-------|----|-----|
| 12600 | 70 | 154 |
| 12600 | 90 | 191 |

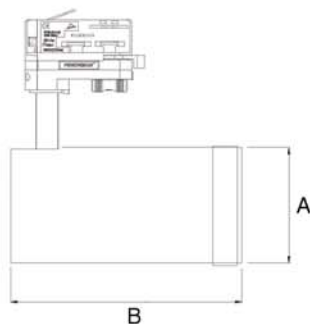

| TYPE  | CRI      | LIGHT OUT | POWER | COLOR TEMP  |
|-------|----------|-----------|-------|-------------|
| 12600 | >90 Ra   | 1500 lm   | 15 W  | 3000K Black |
| 12610 | >90 Ra   | 1500 lm   | 15 W  | 3000K White |
| 12620 | Barndoor |           | 15 W  |             |
| 12700 | >90 Ra   | 3000 lm   | 30 W  | 3000K Black |
| 12710 | >90 Ra   | 3000 lm   | 30 W  | 3000K White |
| 12720 | Barndoor |           | 30 W  |             |

**DESCRIPTION**

Spotlight for track system with incorporated electronic gear.

Housing made of die cast aluminium.

Easy to change.

Philips SLM slim system allow to produce fixture of homogenous lighting performance and high-efficiency natural looking light

Compact design with perfect optical lens and narrow beam angle.

Beam angle:  
20° / 30°

Certificates: CE/ETL/CCC

Colors: White/black/silver



|            |                         |           |        |              |              |                   |             |
|------------|-------------------------|-----------|--------|--------------|--------------|-------------------|-------------|
| <b>LED</b> | <b>5 YEARS WARRANTY</b> | <b>CE</b> | 50000h | L 70<br>B 50 | MacAdam<br>3 | IP<br>20          | Hg<br>0.0mg |
|            |                         |           |        |              |              | ON OFF<br>>100000 | 80%<br>≤1S  |

**PHOTOMETRIC CURVE**

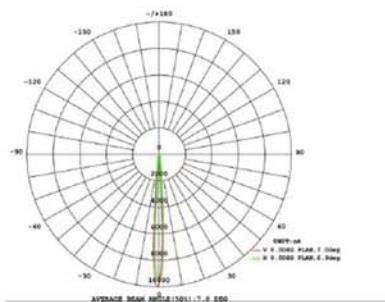

**AREA OF USE**

Display windows, shops and other public places

**CAN BE DELIVERED WITH:**

- 2700K
- 4000K
- 5000K

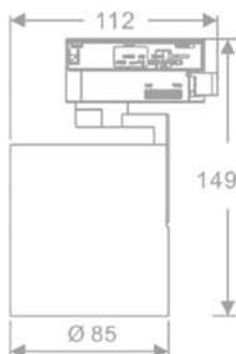

| TYPE  | CRI    | LIGHT OUT | POWER | COLOR TEMP |
|-------|--------|-----------|-------|------------|
| 12510 | >80 Ra | 2000 lm   | 11 W  | 3000K      |



# Dione Mini

LED TRACKLIGHT

## DESCRIPTION

Spotlight for track system with incorporated electronic gear.

Housing made of die cast aluminium.

Easy to change.

Philips SLM slim system allow to produce fixture of homogenous lighting performance and high-efficiency natural looking light.

Spot head can adjust 100°, Rotate 355°

Driver: Philips

Certificates: CE/ETL/CCC

Beam angle 12°/24°/36°/50°

Colors: White/black/silver



## PHOTOMETRIC CURVE

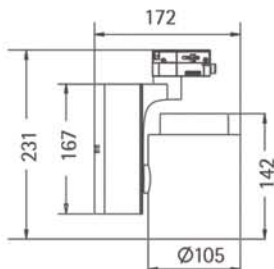
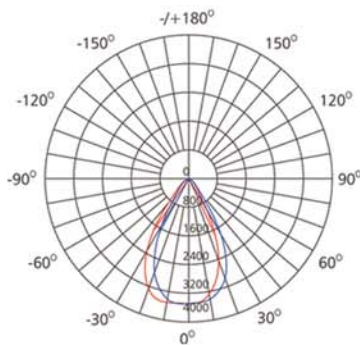

## AREA OF USE

Display windows, shops and other public places

## CAN BE DELIVERED WITH:

- 2700K
- 4000K
- 5000K
- Food COB
- Meat COB

| TYPE  | CRI    | LIGHT OUT | POWER | COLOR TEMP |
|-------|--------|-----------|-------|------------|
| 10500 | >80 Ra | 2000 lm   | 11 W  | 3000K      |
| 10500 | >80 Ra | 3000 lm   | 20 W  | 3000K      |
| 10500 | >80 Ra | 3500 lm   | 24 W  | 3000K      |
| 10500 | >80 Ra | 4000 lm   | 27 W  | 3000K      |
| 10500 | >80 Ra | 4500 lm   | 31 W  | 3000K      |
| 10500 | >80 Ra | 5000 lm   | 37 W  | 3000K      |
| 10500 | >90 Ra | 2000 lm   | 16 W  | 3000K      |
| 10500 | >90 Ra | 3000 lm   | 24 W  | 3000K      |
| 10500 | >90 Ra | 3500 lm   | 27 W  | 3000K      |
| 10500 | >90 Ra | 4000 lm   | 31 W  | 3000K      |
| 10500 | >90 Ra | 4500 lm   | 37 W  | 3000K      |

## DESCRIPTION

Spotlight for track system with incorporated electronic gear.

Housing made of die cast aluminium.

Easy to change.

Philips SLM slim system allow to produce fixture of homogenous lighting performance and high-efficiency natural looking light.

Spot head can adjust 100°, Rotate 355°

Driver: Philips

Certificates: CE/ETL/CCC

Beam angle: 24°/36°

Colors: White/black/silver



LED

5  
YEARS  
WARRANTY

CE

50000h

L 70  
B 50

MacAdam  
3

IP  
20

Hg  
0.0mg

## PHOTOMETRIC CURVE

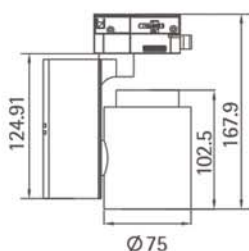
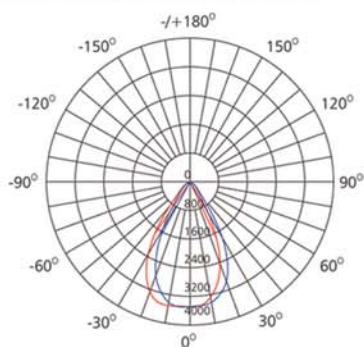

## AREA OF USE

Display windows, shops and other public places

## CAN BE DELIVERED WITH:

- 2700K
- 4000K
- 5000K
- Food COB
- Meat COB

| TYPE  | CRI    | LIGHT OUT | POWER | COLOR TEMP |
|-------|--------|-----------|-------|------------|
| 10600 | >80 Ra | 2000 lm   | 11 W  | 3000K      |
| 10600 | >80 Ra | 3000 lm   | 20 W  | 3000K      |
| 10600 | >90 Ra | 2000 lm   | 16 W  | 3000K      |



## DESCRIPTION

Spotlight for track system with incorporated electronic gear.

Housing made of die cast aluminium.

Easy to change.

Philips SLM slim system allow to produce fixture of homogenous lighting performance and high-efficiency natural looking light.

Driver: Philips

Certificates: CE/ETL/CCC

Beam angle 12°/24°/36°/50°

Colors: White/black/silver



## PHOTOMETRIC CURVE

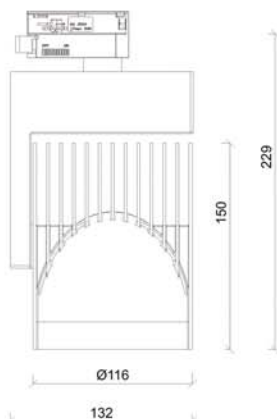
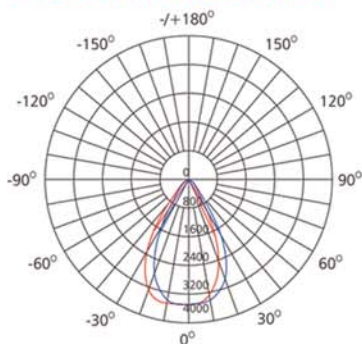

## AREA OF USE

Display windows, shops and other public places

## CAN BE DELIVERED WITH

- 2700K
- 4000K
- 5000K
- Food COB
- Meat COB

| TYPE  | CRI    | LIGHT OUT | POWER | COLOR TEMP |
|-------|--------|-----------|-------|------------|
| 10700 | >80 Ra | 3000 lm   | 20 W  | 3000K      |
| 10700 | >80 Ra | 3500 lm   | 24 W  | 3000K      |
| 10700 | >80 Ra | 4000 lm   | 27 W  | 3000K      |
| 10700 | >80 Ra | 4500 lm   | 31 W  | 3000K      |
| 10700 | >80 Ra | 5000 lm   | 37 W  | 3000K      |
| 10700 | >90 Ra | 3000 lm   | 24 W  | 3000K      |
| 10700 | >90 Ra | 3500 lm   | 27 W  | 3000K      |
| 10700 | >90 Ra | 4000 lm   | 31 W  | 3000K      |
| 10700 | >90 Ra | 4500 lm   | 37 W  | 3000K      |
| 10700 | >90 Ra | 5000 lm   | 38 W  | 3000K      |







## DESCRIPTION

Spotlight for track system with incorporated electronic gear.

Housing made of die cast aluminium.

Easy to change.

Philips SLM slim system allow to produce fixture of homogenous lighting performance and high-efficiency natural looking light. Also with using high efficiency reflector, it can be performed in various beam angles.

Driver: Philips

Certificates: CE/ETL/CCC

Beam angel: 15°/24°/36°/60°

Colors: White/black/silver

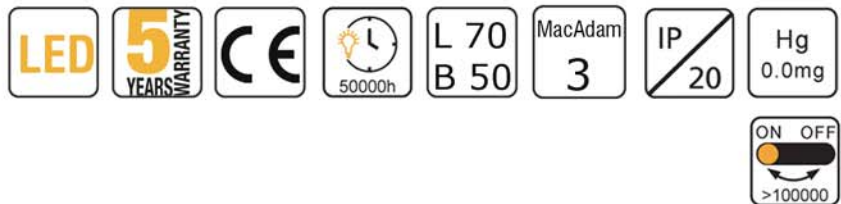

## PHOTOMETRIC CURVE

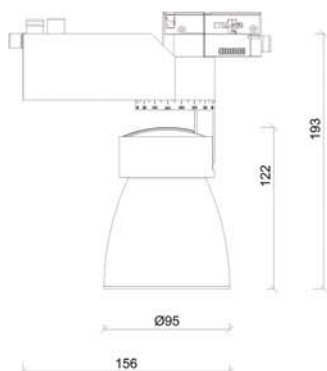
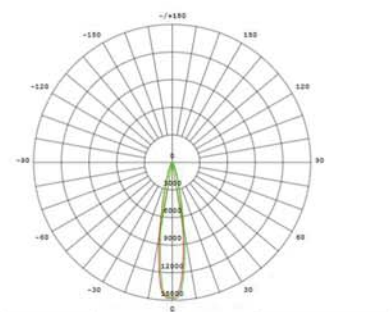

## AREA OF USE

Display windows, shops and other public places

## CAN BE DELIVERED WITH

- 2700K
- 4000K
- 5000K
- Food COB
- Meat COB

| TYPE  | CRI    | LIGHT OUT | POWER | COLOR TEMP |
|-------|--------|-----------|-------|------------|
| 11100 | >80 Ra | 2000 lm   | 11 W  | 3000K      |
| 11100 | >80 Ra | 3000 lm   | 20 W  | 3000K      |
| 11100 | >80 Ra | 3500 lm   | 24 W  | 3000K      |
| 11100 | >80 Ra | 4000 lm   | 27 W  | 3000K      |
| 11100 | >80 Ra | 4500 lm   | 31 W  | 3000K      |
| 11100 | >90 Ra | 2000 lm   | 16 W  | 3000K      |
| 11100 | >90 Ra | 3000 lm   | 24 W  | 3000K      |
| 11100 | >90 Ra | 3500 lm   | 27 W  | 3000K      |
| 11100 | >90 Ra | 4000 lm   | 31 W  | 3000K      |

# Leda 2

## DESCRIPTION

Spotlight for track system with incorporated electronic gear.

Housing made of die cast aluminium.

Easy to change.

Philips SLM G7 slim system allow to produce fixture of homogenous lighting performance and high-efficiency natural looking light. Also with using high efficiency reflector, it can be performed in various beam angles.

Driver: Philips

Beam angle 12°/24°/36°

Colors: White/black/silver



LED TRACKLIGHT

## PHOTOMETRIC CURVE

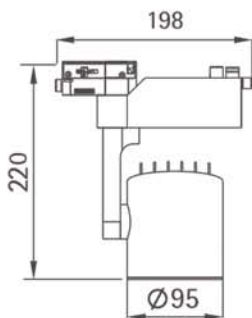
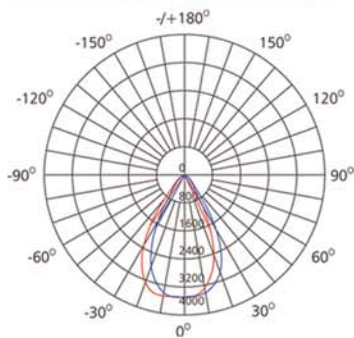

## AREA OF USE

Display windows, shops and other public places

## CAN BE DELIVERED WITH

- 2700K
- 4000K
- 5000K
- Food COB
- Meat COB

| TYPE  | CRI    | LIGHT OUT | POWER | COLOR TEMP |
|-------|--------|-----------|-------|------------|
| 10800 | >80 Ra | 2000 lm   | 11 W  | 3000K      |
| 10800 | >80 Ra | 3000 lm   | 20 W  | 3000K      |
| 10800 | >80 Ra | 3500 lm   | 24 W  | 3000K      |
| 10800 | >80 Ra | 4000 lm   | 27 W  | 3000K      |
| 10800 | >80 Ra | 4500 lm   | 31 W  | 3000K      |
| 10800 | >90 Ra | 2000 lm   | 16 W  | 3000K      |
| 10800 | >90 Ra | 3000 lm   | 24 W  | 3000K      |
| 10800 | >90 Ra | 3500 lm   | 27 W  | 3000K      |
| 10800 | >90 Ra | 4000 lm   | 31 W  | 3000K      |

**DESCRIPTION**

The slim head pivot can be adjusted through 90° and rotates through 355°. Housing made of extruded aluminum with highly pure powder coating. It mounts COB led. The fixture has a low glare and it is useful for many tasks. DC/DC converter included and integrated into the track adapter. Luminous efficacy 130 Lm/W

Certificates: CE/CCC

Colors: White/black/silver

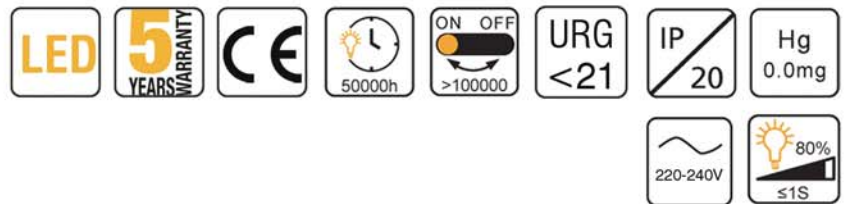

**PHOTOMETRIC CURVE**

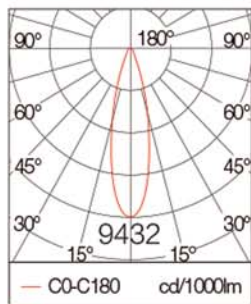

**AREA OF USE**

Display windows, shops and other public places

**CAN BE DELIVERED WITH:**

Beam angle 15°/24°/36°/60°/75°  
Clear / frosted  
On/of driver/Casambi driver/Dali driver.

|             | A   | B  | C   |
|-------------|-----|----|-----|
| 10750/10751 | 169 | 70 | 100 |

| TYPE  | CRI    | LIGHT OUT | POWER | COLOR TEMP | COLOR |
|-------|--------|-----------|-------|------------|-------|
| 10750 | >80 Ra | 3000 lm   | 28 W  | 3000K      |       |
| 10751 | >80 Ra | 3000 lm   | 28 W  | 3000K      |       |

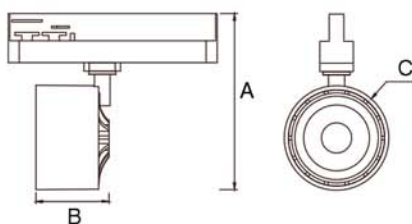





## DESCRIPTION

Spotlight for track system with incorporated electronic gear.

Housing made of die-cast aluminium.

Easy to change.

Without light source.  
Max 10W

Certificates: CE/ETL/CCC

Colors: White/black

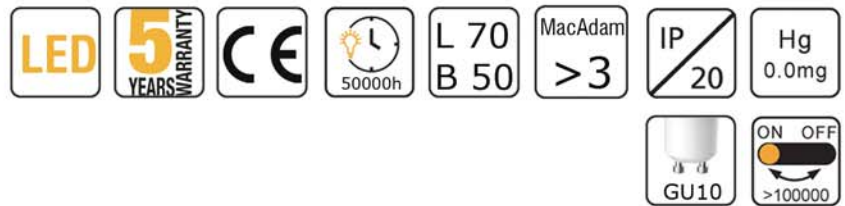

## PHOTOMETRIC CURVE

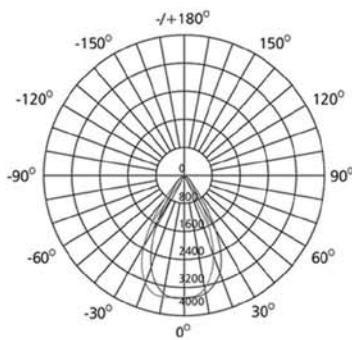

## AREA OF USE

Display windows, shops and other public places

| TYPE     | CRI    | LIGHT OUT | POWER | COLOR TEMP |
|----------|--------|-----------|-------|------------|
| 307206-1 | >90 Ra | 280 lm    | 3,9W  | 3000K      |
| 307206-1 | >90 Ra | 375 lm    | 5,5W  | 3000K      |

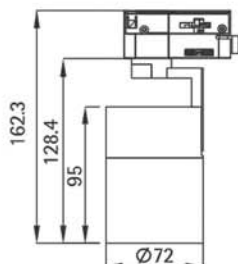



## DESCRIPTION

This spot track light allow your GU10 spotlights to be track rail version, By making use of universal 1/3-phase track rails, one can obtain functional and adaptive lighting that is ideal as accent lighting. The spots can be easily mounted and tilted.

Dimmable  
Light source: GU10.

Materials: 6063 brushed Aluminum alloy

Spot head can adjust 90°,  
Rotate 350°

Certificates: CE

Colors: White/Black

Ring: White/Black/Gold

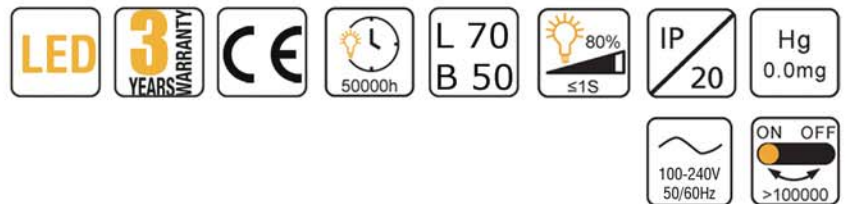

## AREA OF USE

Shops, Museums, Art Galleries, Exhibition Halls, Libraries, Bakeries and other public places

## CAN BE DELIVERED WITH:

Kelvin: 2700K/3000K/4000K/5000K  
Wattage: Max. 10W

|          | A   | B  | C  | D  | E   |
|----------|-----|----|----|----|-----|
| 11510-21 | 130 | 63 | 31 | 70 | 129 |

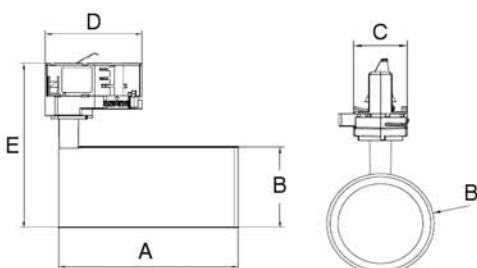

| TYPE  | POWER | HOUSING | RING   |
|-------|-------|---------|--------|
| 11510 | 10 W  | BLACK   | BLACK  |
| 11511 | 10 W  | BLACK   | GOLDEN |
| 11520 | 10 W  | WHITE   | WHITE  |
| 11521 | 10 W  | WHITE   | GOLDEN |



## DESCRIPTION

Spotlight for track system with incorporated electronic gear.

Housing made of die cast aluminium.

Easy to change.

Driver: Philips Xitanium

Luminous efficiency:  
120-130lm/w

Spot head can adjust 90°,  
Rotate 350°

Certificates: CE

Beam angle 12°/24°/36°/50°

Colors: White/black/silver

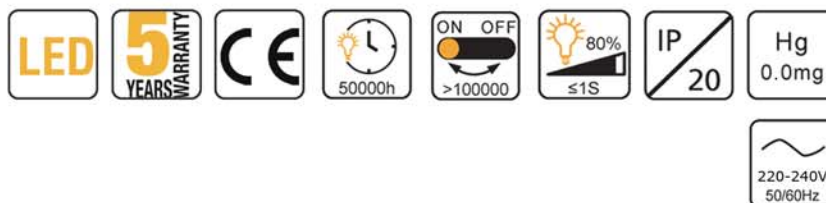

## AREA OF USE

Display windows, shops and other public places

## CAN BE DELIVERED WITH:

2700K/3000K/3500K/4000K  
High efficiency reflector

|       | A   | B    | C   |
|-------|-----|------|-----|
| 10650 | 157 | Ø90  | 91  |
| 10660 | 162 | Ø100 | 96  |
| 10670 | 166 | Ø110 | 100 |

| TYPE  | CRI    | LIGHT OUT | POWER | COLOR TEMP |
|-------|--------|-----------|-------|------------|
| 10650 | >90 Ra | 2600 lm   | 20 W  | 3000K      |
| 10660 | >90 Ra | 3600 lm   | 30 W  | 3000K      |
| 10670 | >90 Ra | 4800 lm   | 40 W  | 3000K      |

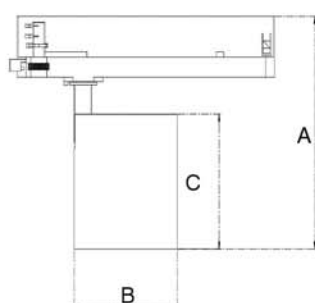

# Triton Micro

## DESCRIPTION

Spotlight for track system with incorporated electronic gear.

Housing made of die cast aluminium.

Easy to change.

Philips SLM slim system allow to produce fixture of homogenous lighting performance and high-efficiency natural looking light.

Spot head can adjust 90°, Rotate 355°

Driver: Philips

Certificates: CE/ETL/CCC

Beam angle 12°/24°/36°

Colors: White/black/silver



**LED**

**5**  
YEARS WARRANTY

**CE**

50000h

L 70  
B 50

MacAdam  
**3**

IP  
**20**

Hg  
0.0mg

ON OFF  
>100000

## PHOTOMETRIC CURVE

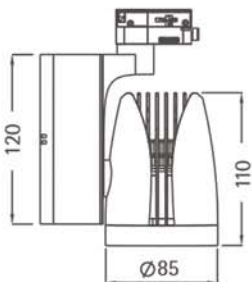
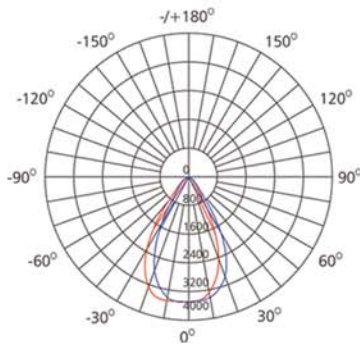

## AREA OF USE

Display windows, shops and other public places

## CAN BE DELIVERED WITH

- 2700K
- 4000K
- 5000K
- Food COB
- Meat COB

| TYPE  | CRI    | LIGHT OUT | POWER | COLOR TEMP |
|-------|--------|-----------|-------|------------|
| 11200 | >80 Ra | 2000 lm   | 11 W  | 3000K      |
| 11200 | >80 Ra | 3000 lm   | 20 W  | 3000K      |
| 11200 | >90 Ra | 2000 lm   | 16 W  | 3000K      |

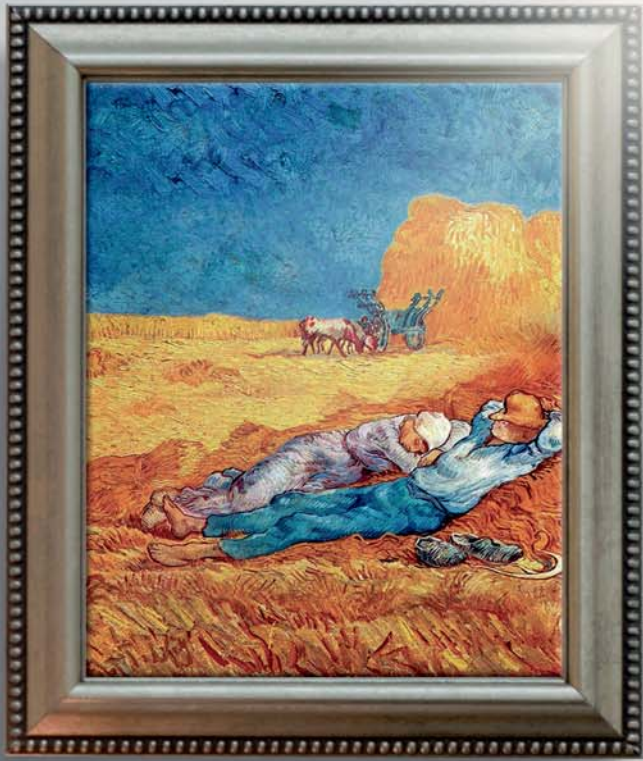



# Triton Mini

## DESCRIPTION

Spotlight for track system with incorporated electronic gear.

Housing made of die cast aluminium.

Easy to change.

Philips SLM slim system allow to produce fixture of homogenous lighting performance and high-efficiency natural looking light.

Spot head can adjust 90°, Rotate 355°

Driver: Philips

Certificates: CE/ETL/CCC

Beam angle 12°/24°/36°

Colors: White/black/silver



## PHOTOMETRIC CURVE

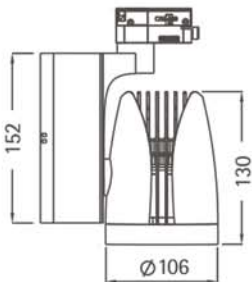
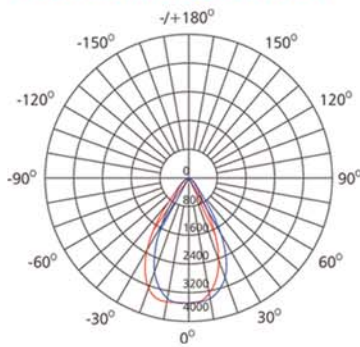

## AREA OF USE

Display windows, shops and other public places

## CAN BE DELIVERED WITH

- 2700K
- 4000K
- 5000K
- Food COB
- Meat COB

| TYPE  | CRI    | LIGHT OUT | POWER | COLOR TEMP |
|-------|--------|-----------|-------|------------|
| 11300 | >80 Ra | 2000 lm   | 11 W  | 3000K      |
| 11300 | >80 Ra | 3000 lm   | 20 W  | 3000K      |
| 11300 | >80 Ra | 3500 lm   | 24 W  | 3000K      |
| 11300 | >80 Ra | 4000 lm   | 27 W  | 3000K      |
| 11300 | >80 Ra | 4500 lm   | 31 W  | 3000K      |
| 11300 | >90 Ra | 2000 lm   | 16 W  | 3000K      |
| 11300 | >90 Ra | 3000 lm   | 24 W  | 3000K      |
| 11300 | >90 Ra | 3500 lm   | 27 W  | 3000K      |
| 11300 | >90 Ra | 4000 lm   | 31 W  | 3000K      |

## DESCRIPTION

Spotlight for track system with incorporated electronic gear.

Housing made of die cast aluminium.

Easy to change.

Philips SLM slim system allow to produce fixture of homogenous lighting performance and high-efficiency natural looking light.

Spot head can adjust 90°, Rotate 355°

Driver: Philips

Certificates: CE/ETL/CCC

Beam angle 12°/24°/36°/50°

Colors: White/black/silver



**LED**

**5 YEARS WARRANTY**

**CE**

50000h

L 70  
 B 50

MacAdam  
 3

IP  
 20

Hg  
 0.0mg

## PHOTOMETRIC CURVE

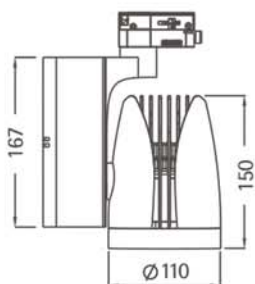
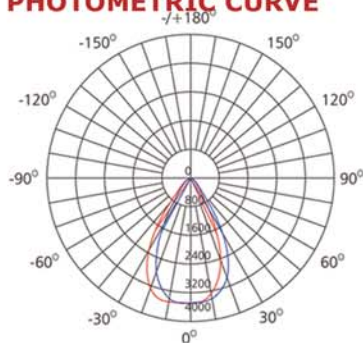

## AREA OF USE

Display windows, shops and other public places

## CAN BE DELIVERED WITH

- 2700K
- 4000K
- 5000K
- Food COB
- Meat COB

| TYPE  | CRI    | LIGHT OUT | POWER | COLOR TEMP |
|-------|--------|-----------|-------|------------|
| 11400 | >80 Ra | 3000 lm   | 20 W  | 3000K      |
| 11400 | >80 Ra | 3500 lm   | 24 W  | 3000K      |
| 11400 | >80 Ra | 4000 lm   | 27 W  | 3000K      |
| 11400 | >80 Ra | 4500 lm   | 31 W  | 3000K      |
| 11400 | >80 Ra | 5000 lm   | 37 W  | 3000K      |
| 11400 | >90 Ra | 3000 lm   | 24 W  | 3000K      |
| 11400 | >90 Ra | 3500 lm   | 27 W  | 3000K      |
| 11400 | >90 Ra | 4000 lm   | 31 W  | 3000K      |
| 11400 | >90 Ra | 4500 lm   | 37 W  | 3000K      |
| 11400 | >90 Ra | 5000 lm   | 38 W  | 3000K      |

## DESCRIPTION

Track mounted/ surface mounted or suspending.

Luminous efficacy 100 Lm/W

Dimmable

Certificates: CE

Beam angle 120°

Colors: Black



## TRACK MOUNTED



## AREA OF USE

Display windows, shops and other public places

## CAN BE DELIVERED WITH:

3000K  
4000K  
6000K

|       | DIAMETER | TRACK MOUNT. (T)<br>SUSPENDING (S)<br>SURF. MOUNT. (SP) |
|-------|----------|---|
| 13500 | Ø200     | T   |
| 13501 | Ø250     | T+S+SP  |
| 13502 | Ø300     | T+S+SP  |
| 13503 | Ø450     | S+SP  |
| 13504 | Ø600     | S+SP  |

| TYPE  | CRI    | LIGHT OUT | POWER | COLOR TEMP |
|-------|--------|-----------|-------|------------|
| 13500 | >80 Ra | 2000 lm   | 20 W  | 3000K      |
| 13501 | >80 Ra | 2400 lm   | 24 W  | 3000K      |
| 13502 | >80 Ra | 3000 lm   | 30 W  | 3000K      |
| 13503 | >80 Ra | 4800 lm   | 48 W  | 3000K      |
| 13504 | >80 Ra | 6000 lm   | 60 W  | 3000K      |

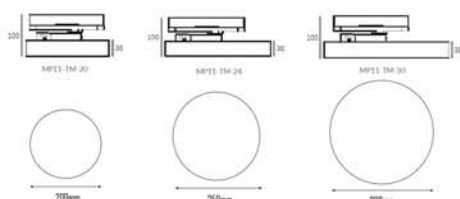



## DESCRIPTION

Linear light for track system with incorporated electronic gear. Install mixture with track light and emergency sign light etc

Luminous efficacy: 130lm/W.

LED: Epistar Chip and PLCC package.

Customized length and watts  
Dimmable: DALI/TRAIC/0-10V

Certificates: CE

Colors: Black

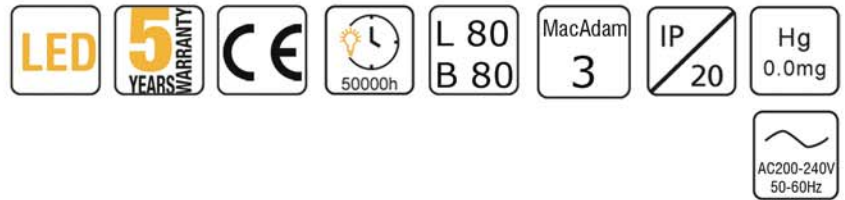

## PHOTOMETRIC CURVE

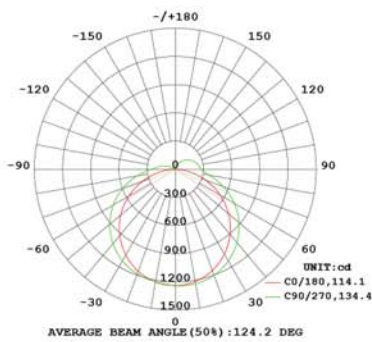

|  | A     | B    | C  | D  | E         |
|--|-------|------|----|----|-----------|
|  | 12150 | 1105 | 73 | 45 | 1005 1016 |

## AREA OF USE

Supermarket, Office, Commercial lighting, Library, Showroom etc.

## CAN BE DELIVERED WITH:

- 3000K
- 4000K
- 5000K

| TYPE  | CRI    | LIGHT OUT | POWER | COLOR TEMP |
|-------|--------|-----------|-------|------------|
| 12150 | >80 Ra | 1950 lm   | 15 W  | 4000K      |
| 12160 | >80 Ra | 1950 lm   | 15 W  | 3000K      |
| 12170 | >80 Ra | 3900 lm   | 30 W  | 4000K      |
| 12180 | >80 Ra | 3900 lm   | 30 W  | 3000K      |

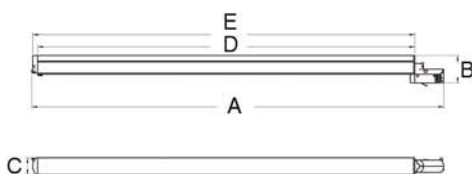



**FLAT PANEL**



## DESCRIPTION

The track light series is highly versatile, which combines with PMMA lens optics 30°, 60°, 90°, double asymmetric 20° for options.

This makes it easy to install and to replace or update when re-using existing track for General lighting.

Besides, it has thin body, light weight and compact structure, suitable for standard three-circuit track system.

Luminous efficacy: 130-140 Lm/W

Housing made of die cast aluminium.

Type A with an adapter at the side while type B with adapter at the back and can do 350 degree rotary.

Certificates: CE/ETL/CCC

Beam angle 30°/ 60°/ 90°/  
Double Asymmetrical 20°

Colors: White

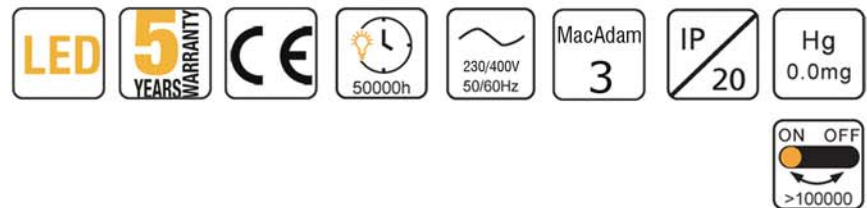
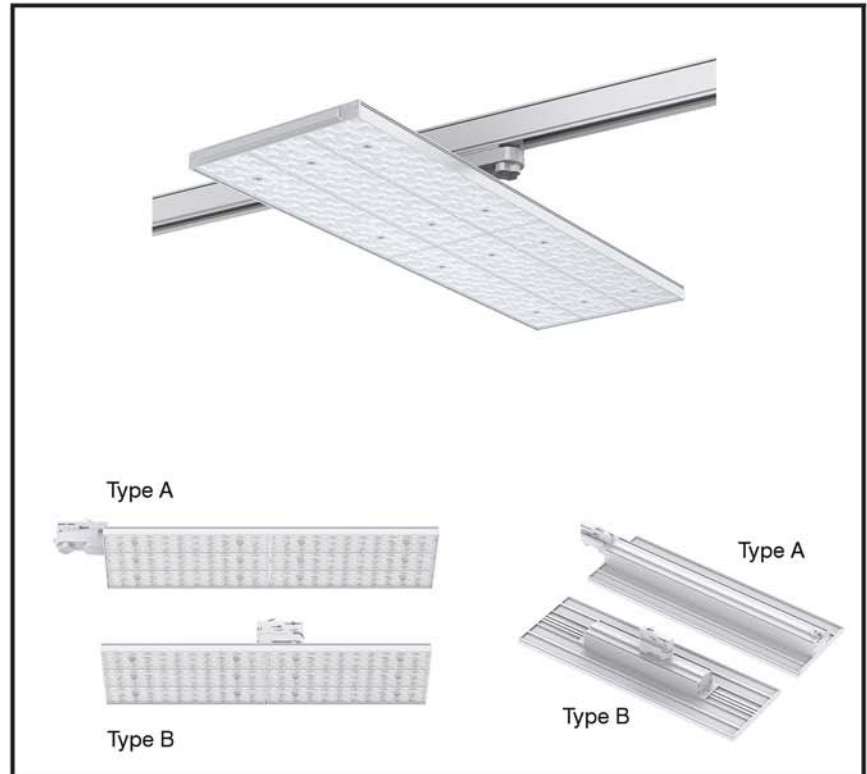

## AREA OF USE

Shops, exhibition hall, shopping mall, jewelry store, supermarket and other public places

## CAN BE DELIVERED WITH:

3000K/4000K/5000K/5700K

|        | A   | B   | C   |
|--------|-----|-----|-----|
| Type A | 670 | 190 | 80  |
| Type B | 582 | 190 | 116 |

| TYPE  | CRI    | LIGHT OUT | POWER | COLOR TEMP |
|-------|--------|-----------|-------|------------|
| 12300 | >80 Ra | 6760 lm   | 50 W  | 3000K      |
| 12301 | >80 Ra | 7940 lm   | 60 W  | 3000K      |
| 12302 | >80 Ra | 10240 lm  | 80 W  | 3000K      |
| 12303 | >80 Ra | 6760 lm   | 50 W  | 3000K      |
| 12304 | >80 Ra | 7940 lm   | 60 W  | 3000K      |
| 12305 | >80 Ra | 10240 lm  | 80 W  | 3000K      |



# Gamma

LED TRACKLIGHT

## DESCRIPTION

Gamma linear light for track system with incorporated electronic gear.

Housing made of die cast aluminium.

Easy to change.

Can be linkable

Luminous efficacy: 100Lm/W

Certificates: CE/RoHS

Beam angle 30°

Colors: Black



|            |                         |           |        |               |                  |              |                 |
|------------|-------------------------|-----------|--------|---------------|------------------|--------------|-----------------|
| <b>LED</b> | <b>5 YEARS WARRANTY</b> | <b>CE</b> | 50000h | <b>UGR 19</b> | <b>MacAdam 3</b> | <b>IP 20</b> | <b>Hg 0.0mg</b> |
|            |                         |           |        |               |                  |              | >100000         |

## AREA OF USE

Warehouse and factories

## CAN BE DELIVERED WITH

Dimming: 1-10V/DALI  
CCT setting: 2700-6500K

|       | A  | B  | C    |
|-------|----|----|------|
| 12400 | 85 | 38 | 1094 |

| TYPE  | CRI    | LIGHT OUT | POWER | COLOR TEMP |
|-------|--------|-----------|-------|------------|
| 12400 | >80 Ra | 3000 lm   | 30 W  | 4000K      |

## DESCRIPTION

Spotlight for track system with incorporated electronic gear.

Adjustable 1 axis: 35°

Luminous efficacy: 130 Lm/W

Housing made of extruded aluminum with highly pure powder coating.

Beam angle 12°/ 20°/ 34°/ 40°/ 48°

Certificates: CE

Colors: White/black/grey

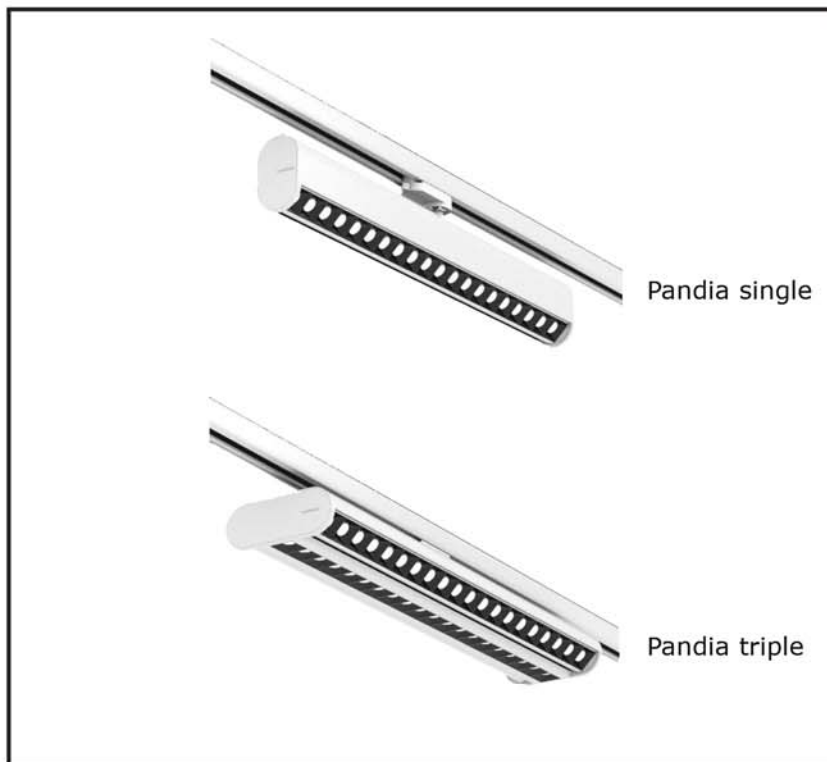

## PHOTOMETRIC CURVE

34°-4000K-CRI90

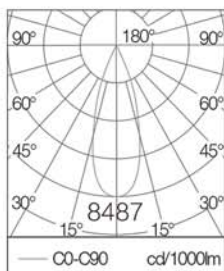

|          | A   | B   | C  |
|----------|-----|-----|----|
| 10650-51 | 600 | 55  | 89 |
| 10652    | 600 | 143 | 89 |

## AREA OF USE

Display windows, shops and other public places

## CAN BE DELIVERED WITH:

2700K/3000K/4000K/5000K

Powergear adaptor: 4wire 3phase or 6wire 3phase

Dimming: On-Off/DALI/Casambi

| TYPE  | CRI   | LIGHT OUT | POWER  | KELVIN |
|-------|-------|-----------|--------|--------|
| 10650 | 90 Ra | 3900 Lm   | 30 W   | 3000K  |
| 10651 | 90 Ra | 5200 Lm   | 40 W   | 3000K  |
| 10652 | 90 Ra | 11200 Lm  | 3x30 W | 3000K  |

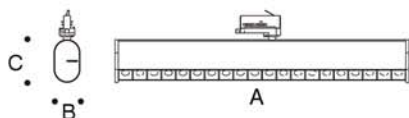

**DESCRIPTION**

Spotlight for track system with incorporated electronic gear.

Available in 2 powers with 1 dimensions.

Housing made of extruded aluminum with highly pure powder coating.

Luminous efficacy 70 lm/W

The fixture has a low glare and it is useful for many tasks. It mounts SMD led.

Dimming: On-Off/DALI/1-10V/ Casambi

Spot head can adjust 90°, Rotate 355°

Certificates: CE/CCC

Beam angle 15°/30°/45°

Colors: White/black/silver



**PHOTOMETRIC CURVE**

30°-3000K-20W-CRI90

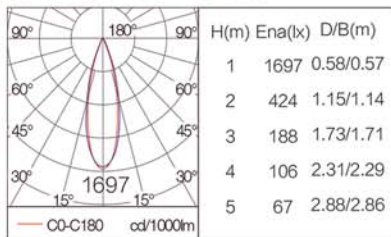

**AREA OF USE**

Display windows, shops and other public places

**CAN BE DELIVERED WITH:**

- 5 kinds of colors for secondary optic can be optional
- Black color
- White color
- Silver color
- Gold color
- Rose gold color

| TYPE  | CRI    | LIGHT OUT | POWER | COLOR TEMP |
|-------|--------|-----------|-------|------------|
| 13011 | >90 Ra | 2100 lm   | 30 W  | 3000K      |

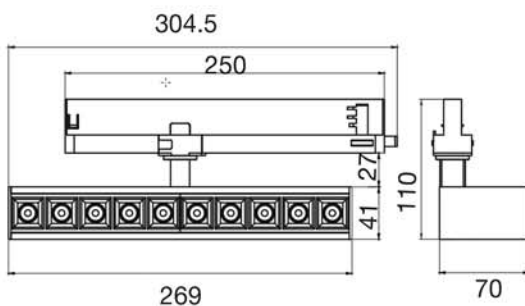



# Bricks Adjustable

## DESCRIPTION

Easy installation  
 3-5 seconds quick installation.  
 Bricks is a revolutionary change for conventional trunking system linear light.  
 The installation position of the luminaire is adjustable.

Material: Aviation aluminum.

Philips driver.

Use standard 3 circuits track for installation

Light Efficiency: 130LM/W

Certificates: CE/RoHS

Adjustable angle  $\pm 60^\circ$

Colors: White/black



|               |                         |                  |        |                  |                  |              |                 |  |
|---------------|-------------------------|------------------|--------|------------------|------------------|--------------|-----------------|--|
| <b>LED</b>    | <b>5 YEARS WARRANTY</b> | <b>CE</b>        | 50000h | <b>L 70 B 50</b> | <b>MacAdam 3</b> | <b>IP 20</b> | <b>Hg 0.0mg</b> |  |
| 80% $\leq 1S$ | 90-277V 50/60Hz         | ON OFF $>100000$ |        |                  |                  |              |                 |  |

## LIGHTING DISTRIBUTION

Three distribution patterns are available for different application.  
 30\*60° / 60\*90° /Double asymmetric 100°

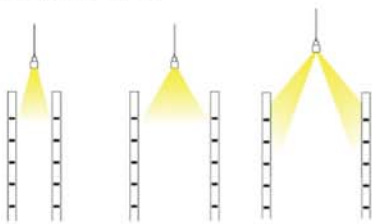

|             | A   | B   | C  |
|-------------|-----|-----|----|
| 11501       | 370 | 108 | 60 |
| 11521/11561 | 370 | 108 | 60 |
| 11541       | 508 | 108 | 60 |

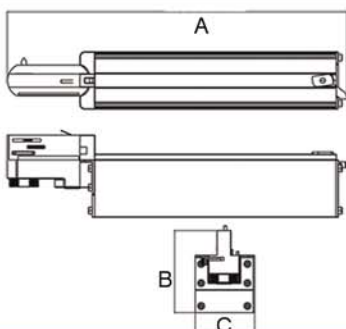

## AREA OF USE

Display windows, shops and other public places

## CAN BE DELIVERED WITH:

3000K/4000K/5000K

## ACCESSORIES



| TYPE  | CRI    | LIGHT OUT | POWER | COLOR TEMP     |
|-------|--------|-----------|-------|----------------|
| 11501 | >80 Ra | 3510 lm   | 27 W  | 4000K          |
| 11521 | >80 Ra | 4680 lm   | 36 W  | 4000K          |
| 11541 | >80 Ra | 7020 lm   | 54 W  | 4000K          |
| 11561 | >80 Ra | 4680 lm   | 36 W  | 3000-5000K CCT |



**ANGEL'S** WINGS



# Bricks Angel Wings

## DESCRIPTION

Easy installation  
3-5 seconds quick installation  
for 3-circuit tracks.

Bricks is a revolutionary  
change for conventional  
trunking system linear  
light.

Beam angle 50°-100° adjusta-  
ble. Double asymmetric.

Microfacet reflector techno-  
logy, avoiding direct glare.

Material: Aviation aluminum.

Philips driver.

Light Efficiency: 100LM/W

Certificates: CE/RoHS

Colors: White/black



|     |                  |    |        |              |                   |            |                     |
|-----|------------------|----|--------|--------------|-------------------|------------|---------------------|
| LED | 5 YEARS WARRANTY | CE | 50000h | L 70<br>B 50 | MacAdam<br>3      | IP<br>20   | Hg<br>0.0mg         |
|     |                  |    |        |              | ON OFF<br>>100000 | 80%<br>≤1S | 200-240V<br>50/60Hz |

## LIGHTING DISTRIBUTION

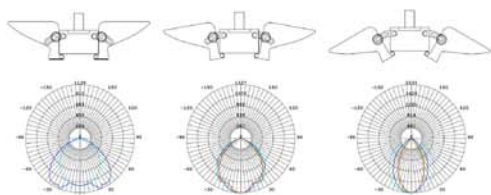

## AREA OF USE

Display windows, shops and other public places

## CAN BE DELIVERED WITH:

- 4000K
- 5000K
- Dali
- 1-10V
- Motion sensor/Daylight sensor

|             | A   | B   | C  |
|-------------|-----|-----|----|
| 11901/21/41 | 500 | 218 | 70 |

| TYPE  | CRI    | LIGHT OUT | POWER | COLOR TEMP |
|-------|--------|-----------|-------|------------|
| 11901 | >80 Ra | 3000 lm   | 30 W  | 3000K      |
| 11921 | >80 Ra | 4000 lm   | 40 W  | 3000K      |
| 11941 | >80 Ra | 6000 lm   | 60 W  | 3000K      |

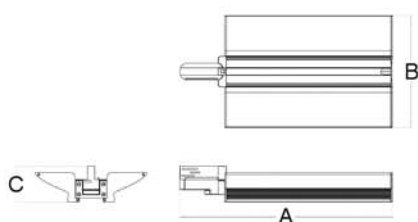



# Bricks Rotatable

## DESCRIPTION

Easy installation  
 3-5 seconds quick installation.  
 Bricks is a revolutionary change for conventional trunking system linear light.

Material: Aviation aluminum.

Philips driver.

Use standard 3 circuits track for installation

Rotate through 350°, tilt through ±60°

Light Efficiency: 130LM/W

Certificates: CE/RoHS

Colors: White/black



LED TRACKLIGHT

|      |                  |         |                 |              |           |       |          |
|------|------------------|---------|-----------------|--------------|-----------|-------|----------|
| LED  | 5 YEARS WARRANTY | CE      | 50000h          | L 70<br>B 50 | MacAdam 3 | IP 20 | Hg 0.0mg |
| 350° | ON OFF >100000   | 80% ≤1S | 90-277V 50/60Hz |              |           |       |          |

## LIGHTING DISTRIBUTION

Three distribution patterns are available for different application.  
 30\*60° / 60\*90° /Double asymmetric 100°

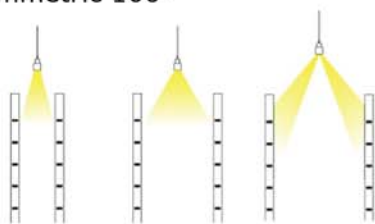

|       | A   | B  | C   |
|-------|-----|----|-----|
| 11660 | 422 | 60 | 148 |

## AREA OF USE

Display windows, shops and other public places

| TYPE  | CRI    | LIGHT OUT             | POWER         | COLOR TEMP |
|-------|--------|-----------------------|---------------|------------|
| 11600 | >80 Ra | 3900/5200/6500/7800lm | 30/40/50/60 W | 3/4/5000K  |

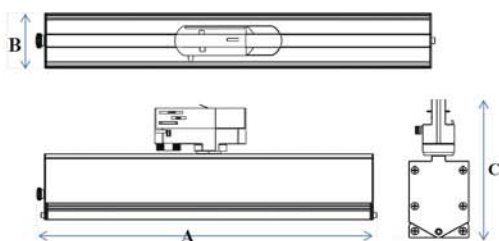

# Bricks Linear A

## DESCRIPTION

Easy installation

3-5 seconds quick installation.

Linear A is a revolutionary change for conventional trunking system linear light.

Use standard 3 circuits track for installation

Driver: Philips

Luminous efficacy: 130Lm/W

Certificates: CE/RoHS

Color: White/black



|     |                  |    |        |              |                   |            |                     |
|-----|------------------|----|--------|--------------|-------------------|------------|---------------------|
| LED | 5 YEARS WARRANTY | CE | 50000h | L 70<br>B 50 | MacAdam<br>3      | IP<br>20   | Hg<br>0.0mg         |
|     |                  |    |        |              | ON OFF<br>>100000 | 80%<br>≤1S | 220-240V<br>50/60Hz |

## TWO DIFFERENT DISTRIBUTIONS

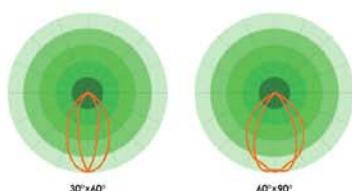

## AREA OF USE

Display windows, shops and other public places

## CAN BE DELIVERED WITH

- 3000K
- 4000K
- 5000K

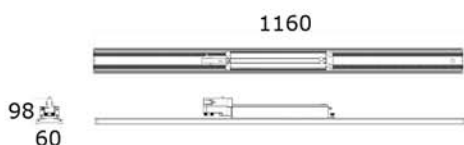

| TYPE  | CRI    | LIGHT OUT | POWER | COLOR TEMP |
|-------|--------|-----------|-------|------------|
| 11800 | >80 Ra | 5200 lm   | 40 W  | 3000K      |
| 11801 | >80 Ra | 5400 lm   | 40 W  | 4000K      |
| 11810 | >80 Ra | 7800 lm   | 60 W  | 3000K      |
| 11811 | >80 Ra | 8100 lm   | 60 W  | 4000K      |
| 11820 | >80 Ra | 10400 lm  | 80 W  | 3000K      |
| 11821 | >80 Ra | 10800 lm  | 80 W  | 4000K      |

# Bricks Linear D

## DESCRIPTION

Easy installation

3-5 seconds quick installation.

Linear A is a revolutionary change for conventional trunking system linear light.

Use standard 3 circuits track for installation

Light Efficiency: 105-120LM/W

Driver: Philips

Certificates: CE/RoHS

Color: White/black

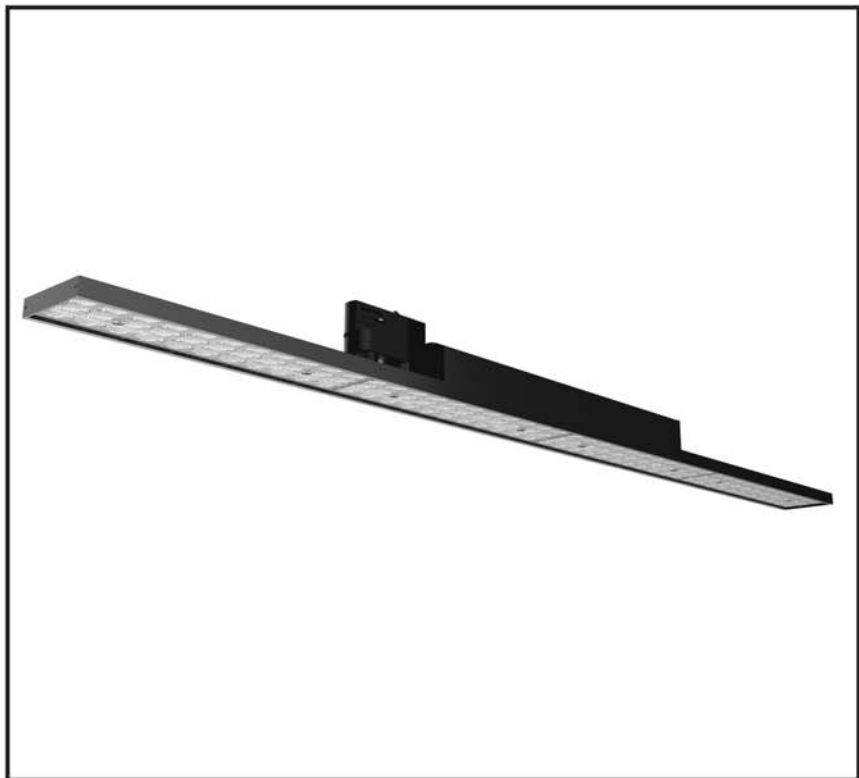

LED TRACKLIGHT

|                 |                         |                   |        |                            |                     |              |             |  |
|-----------------|-------------------------|-------------------|--------|----------------------------|---------------------|--------------|-------------|--|
| <b>LED</b>      | <b>5 YEARS WARRANTY</b> | <b>CE</b>         | 50000h | <b>L 70</b><br><b>B 50</b> | MacAdam<br><b>3</b> | <b>IP 20</b> | Hg<br>0.0mg |  |
| 80%<br>$\le 1s$ | 220-240V<br>50/60Hz     | ON OFF<br>>100000 |        |                            |                     |              |             |  |

## SIX DIFFERENT BEAM ANGLES OPTIONAL

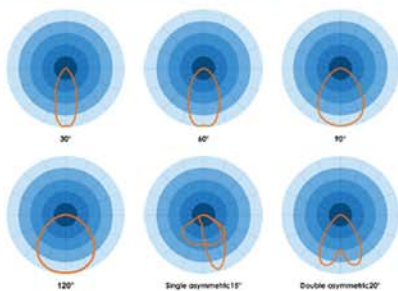

## AREA OF USE

Display windows, shops and other public places

## CAN BE DELIVERED WITH

- 3000K
- 4000K
- 5000K

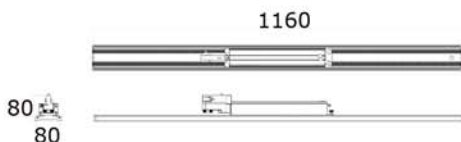

| TYPE  | CRI    | LIGHT OUT | POWER | COLOR TEMP |
|-------|--------|-----------|-------|------------|
| 12200 | >80 Ra | 4400 lm   | 40 W  | 3000K      |
| 12201 | >80 Ra | 4800 lm   | 40 W  | 4000K      |
| 12210 | >80 Ra | 6300 lm   | 60 W  | 3000K      |
| 12211 | >80 Ra | 6900 lm   | 60 W  | 4000K      |
| 12220 | >80 Ra | 8000 lm   | 80 W  | 3000K      |
| 12221 | >80 Ra | 8400 lm   | 80 W  | 4000K      |



## DESCRIPTION

Easy installation

3-5 seconds quick installation. The Bricks track light is a new series of products specially developed for the retail space.

Compared to the traditional linear trunking system light, the bricks uses standart 3 circuits track, which means more flexible for compatibility, and easier for installation. Meanwhile, Bricks has the ability to meet the complex requirements of different environments with various of light distribution design.

Possibility of delivery with double assymmetric light distribution

Use standard 3 circuits track for installation

Luminous efficacy: 130 Lm/W

Driver: Philips

Color: Black/white

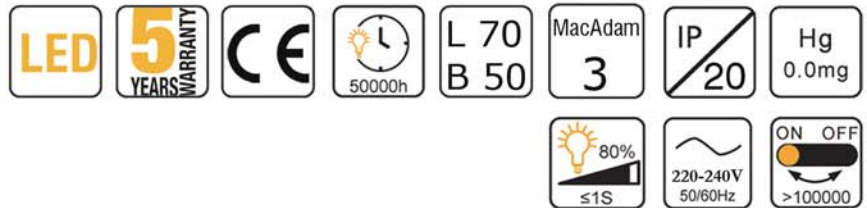

## AREA OF USE

Display windows, shops and other public places

## CAN BE DELIVERED WITH

- 4000K
- 5000K
- Emergency
- CCT changeable: 3000/4000K

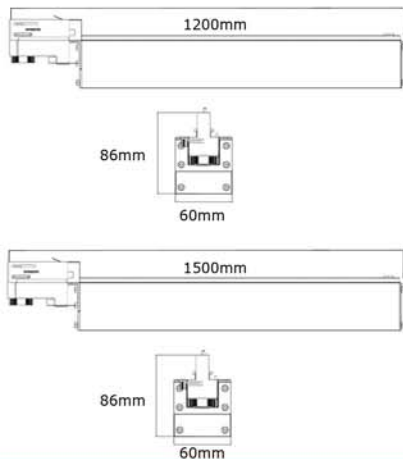

| TYPE  | CRI    | LIGHT OUT | POWER | COLOR TEMP |
|-------|--------|-----------|-------|------------|
| 12100 | >90 Ra | 6500 lm   | 50 W  | 3000K      |
| 12110 | >90 Ra | 7800 lm   | 60 W  | 3000K      |
| 12120 | >90 Ra | 9100 lm   | 70 W  | 3000K      |
| 12180 | >90 Ra |           | 70 W  | 3-4000K    |
| 12134 | >90 Ra |           | 70 W  | 3-4000K    |

**DESCRIPTION**

3-5 seconds quick installation.  
 Use standard 3 circuits track for installation  
 Driver: Osram  
 70x70°

Certificates: CE

Colors: White or black



|     |                  |    |        |                   |            |                     |       |
|-----|------------------|----|--------|-------------------|------------|---------------------|-------|
| LED | 5 YEARS WARRANTY | CE | 50000h | L 70<br>B 50      | MacAdam 3  | Hg 0.0mg            | IP 20 |
|     |                  |    |        | ON OFF<br>>100000 | 80%<br>≤1S | 220-240V<br>50/60Hz | 120°  |

**AREA OF USE**

Shops and other public places

**CAN BE DELIVERED WITH:**

3000K/4000K/5000K

| TYPE  | CRI    | LLIGHT OUT | POWER | COLOR TEMP |
|-------|--------|------------|-------|------------|
| 12560 | >80 Ra | 7000 Lm    | 45 W  | 4000K      |



580





# 3-circuit track

## DESCRIPTION

3-circuit track system with a wide range of installation accessories.

Easy to install.

Can be cut to length on-side. No need of bending tools after cutting.

Three phase conductor (L1, L2, L3), neutral (N) and ground (PE).

250/400 VAC, 16A, 50Hz.

Track's frame material is extruded aluminium. Insulation profiles inside frame are plastic. The tracks contain no Halogen



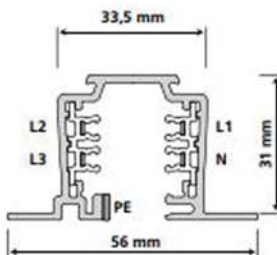
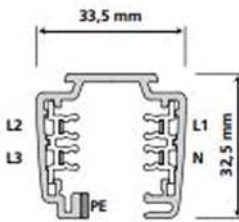
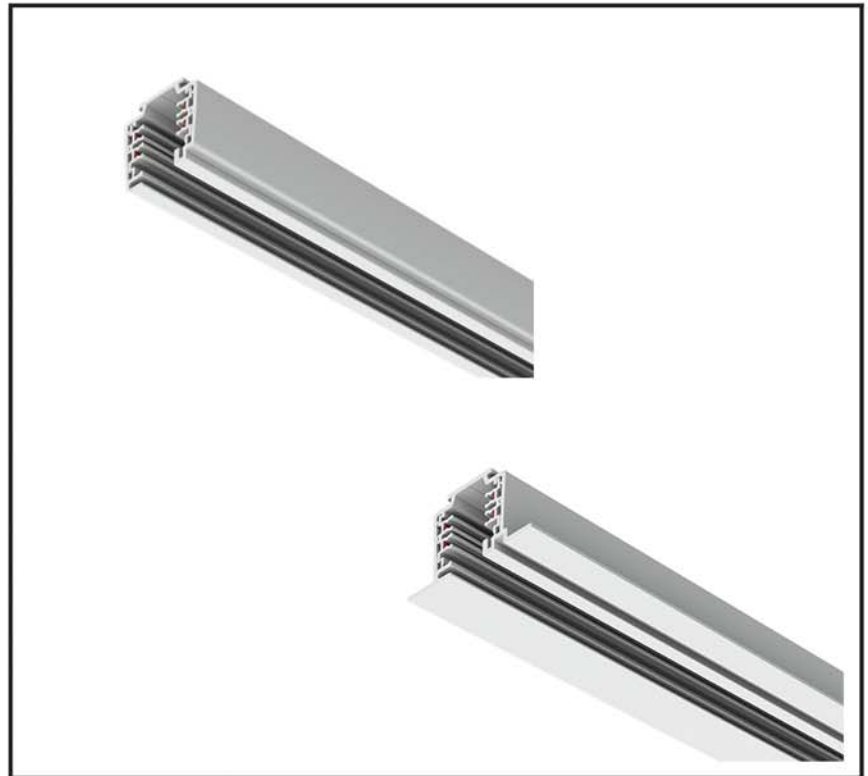









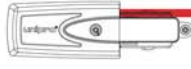
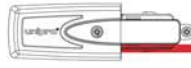

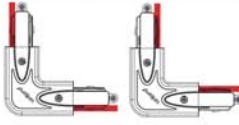
Colors: Black RAL 9005, silver RAL 7040 or white RAL 9010.



| TYPE                    | ART. NO. | COLOR  | LENGHT |
|-------------------------|----------|--------|--------|
| 3-circuit surface track | 1459102  | White  | 2m     |
| 3-circuit surface track | 1459103  | White  | 3m     |
| 3-circuit surface track | 1459104  | White  | 4m     |
| 3-circuit surface track | 1459202  | Silver | 2m     |
| 3-circuit surface track | 1459203  | Silver | 3m     |
| 3-circuit surface track | 1459204  | Silver | 4m     |
| 3-circuit surface track | 1459302  | Black  | 2m     |
| 3-circuit surface track | 1459303  | Black  | 3m     |
| 3-circuit surface track | 1459304  | Black  | 4m     |

| TYPE                     | ART. NO. | COLOR  | LENGHT |
|--------------------------|----------|--------|--------|
| 3-circuit recessed track | 1459112  | White  | 2m     |
| 3-circuit recessed track | 1459113  | White  | 3m     |
| 3-circuit recessed track | 1459114  | White  | 4m     |
| 3-circuit recessed track | 1459212  | Silver | 2m     |
| 3-circuit recessed track | 1459213  | Silver | 3m     |
| 3-circuit recessed track | 1459214  | Silver | 4m     |
| 3-circuit recessed track | 1459312  | Black  | 2m     |
| 3-circuit recessed track | 1459313  | Black  | 3m     |
| 3-circuit recessed track | 1459314  | Black  | 4m     |

# 3-circuit track accessories

| ART. NO. | PRODUCT NAME                      | COLOR                                 | PHOTO   |  |
|----------|-----------------------------------|---------------------------------------|---|--|
| 1459199  | Joining unit                      | Includes grey, black and white covers |   |  |
| 1459121  | Connection unit left              | White                                 |  <br> |  |
| 1459122  | Connection unit right             | White                                 |   |  |
| 1459221  | Connection unit left              | Silver                                |   |  |
| 1459222  | Connection unit right             | Silver                                |   |  |
| 1459321  | Connection unit left              | Black                                 |   |  |
| 1459322  | Connection unit right             | Black                                 |   |  |
| 1459131  | Middle connection                 | White                                 |   |  |
| 1459231  |                                   | Silver                                |   |  |
| 1459331  |                                   | Black                                 |   |  |
| 1459141  | L-corner                          | White                                 |    |  |
| 1459241  |                                   | Silver                                |   |  |
| 1459341  |                                   | Black                                 |   |  |
| 1459161  | T-pieces A                        | White                                 |    |  |
| 1459162  | T-pieces B                        | White                                 |   |  |
| 1459163  | T-pieces C                        | White                                 |   |  |
| 1459164  | T-pieces D                        | White                                 |   |  |
| 1459261  | T-pieces A                        | Silver                                |   |  |
| 1459262  | T-pieces B                        | Silver                                |   |  |
| 1459263  | T-pieces C                        | Silver                                |   |  |
| 1459264  | T-pieces D                        | Silver                                |   |  |
| 1459361  | T-pieces A                        | Black                                 |   |  |
| 1459362  | T-pieces B                        | Black                                 |   |  |
| 1459363  | T-pieces C                        | Black                                 |   |  |
| 1459364  | T-pieces D                        | Black                                 |   |  |
| 1459151  | Adjustable L-corner               | White                                 |   |    |
| 1459251  |                                   | Silver                                |   |  |
| 1459351  |                                   | Black                                 |   |  |
| 1459171  | X-pieces                          | White                                 |   |   |
| 1459271  |                                   | Silver                                |   |  |
| 1459371  |                                   | Black                                 |   |  |
| 1459181  | End cap                           | White                                 |   |  |
| 1459281  |                                   | Silver                                |   |  |
| 1459381  |                                   | Black                                 |   |  |
| 1459407  | Pendant bracket                   | White                                 |   |  |
| 1459408  |                                   | Silver                                |   |  |
| 1459409  |                                   | Black                                 |   |  |
| 1459401  | Ceiling bracket                   | White                                 |   |  |
| 1459402  | For wire suspension set           | Silver                                |   |  |
| 1459403  |                                   | Black                                 |   |  |
| 1459410  | Wire suspension set               | 1,5m                                  |    |  |
| 1459411  | Adjustable<br>For ceiling bracket | 4m                                    |   |  |
| 1460011  | Pendant adaptor                   | White                                 |   |  |
| 1460013  | Pull strength: max 50 N           | Silver                                |   |  |
| 1460012  |                                   | Black                                 |   |  |

# 3-circuit track DALI

## DESCRIPTION

3-circuit track system with a wide range of installation accessories.

Easy to install.

Can be cut to length on-side. No need of bending tools after cutting.

Three phase conductor (L1, L2, L3), neutral (N) and ground (PE).

250/400 VAC, 16A, 50Hz.

Track's frame material is extruded aluminium. Insulation profiles inside frame are plastic. Contain no Halogen.

Colors: Black RAL 9005, silver RAL 7040 or white RAL 9010.

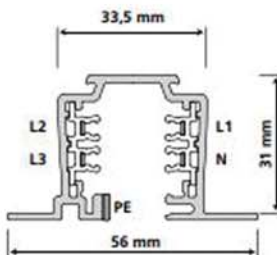
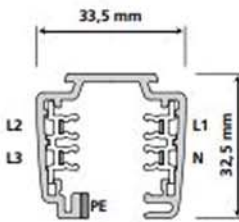
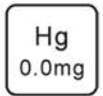



















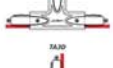

| TYPE                    | ART. NO. | COLOR  | LENGHT | DALI |
|-------------------------|----------|--------|--------|------|
| 3-circuit surface track | 1459107  | White  | 2m     | YES  |
| 3-circuit surface track | 1459108  | White  | 3m     | YES  |
| 3-circuit surface track | 1459109  | White  | 4m     | YES  |
| 3-circuit surface track | 1459207  | Silver | 2m     | YES  |
| 3-circuit surface track | 1459208  | Silver | 3m     | YES  |
| 3-circuit surface track | 1459209  | Silver | 4m     | YES  |
| 3-circuit surface track | 1459307  | Black  | 2m     | YES  |
| 3-circuit surface track | 1459308  | Black  | 3m     | YES  |
| 3-circuit surface track | 1459309  | Black  | 4m     | YES  |

| TYPE                     | ART. NO. | COLOR  | LENGHT | DALI |
|--------------------------|----------|--------|--------|------|
| 3-circuit recessed track | 1459117  | White  | 2m     | YES  |
| 3-circuit recessed track | 1459118  | White  | 3m     | YES  |
| 3-circuit recessed track | 1459119  | White  | 4m     | YES  |
| 3-circuit recessed track | 1459217  | Silver | 2m     | YES  |
| 3-circuit recessed track | 1459218  | Silver | 3m     | YES  |
| 3-circuit recessed track | 1459219  | Silver | 4m     | YES  |
| 3-circuit recessed track | 1459317  | Black  | 2m     | YES  |
| 3-circuit recessed track | 1459318  | Black  | 3m     | YES  |
| 3-circuit recessed track | 1459319  | Black  | 4m     | YES  |

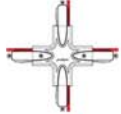

# 3-circuit track accessories DALI

| ART. NO. | PRODUCT NAME               | COLOR                                 | PHOTO   |  |
|----------|----------------------------|---------------------------------------|---|--|
| 1459198  | DALI Jointing unit         | Includes grey, black and white covers |   |  |
| 1459125  | DALI Connection unit left  | White                                 |      |  |
| 1459126  | DALI Connection unit right | White                                 |   |  |
| 1459225  | DALI Connection unit left  | Silver                                |   |  |
| 1459226  | DALI Connection unit right | Silver                                |   |  |
| 1459325  | DALI Connection unit left  | Black                                 |   |  |
| 1459326  | DALI Connection unit right | Black                                 |   |  |
| 1459129  | DALI Middle connection     | White                                 |   |  |
| 1459228  |                            | Silver                                |   |  |
| 1459335  |                            | Black                                 |   |  |
| 1459153  | DALI L-corner              | White                                 |     |  |
| 1459245  |                            | Silver                                |   |  |
| 1459345  |                            | Black                                 |   |  |
| 1459155  | DALI T-pieces A            | White                                 |          |  |
| 1459156  | DALI T-pieces B            | White                                 |   |  |
| 1459157  | DALI T-pieces C            | White                                 |   |  |
| 1459158  | DALI T-pieces D            | White                                 |   |  |
| 1459255  | DALI T-pieces A            | Silver                                |   |  |
| 1459256  | DALI T-pieces B            | Silver                                |   |  |
| 1459257  | DALI T-pieces C            | Silver                                |   |  |
| 1459258  | DALI T-pieces D            | Silver                                |   |  |
| 1459355  | DALI T-pieces A            | Black                                 |   |  |
| 1459356  | DALI T-pieces B            | Black                                 |   |  |
| 1459357  | DALI T-pieces C            | Black                                 |   |  |
| 1459358  | DALI T-pieces D            | Black                                 |   |  |
| 1459167  | DALI X-pieces              | White                                 |   |   |
| 1459275  |                            | Silver                                |   |  |
| 1459375  |                            | Black                                 |   |  |
| 1459196  | DALI End cap               | White                                 |   |    |
| 1459285  |                            | Silver                                |   |  |
| 1459385  |                            | Black                                 |   |  |





### Rhea Micro

Lumen output  
Max. 3000 Lm

Page 50



### Napoli

Lumen output  
Max. 864 Lm

Page 58



### Rhea 2

Lumen output  
Max. 5000 Lm

Page 51



### Milano

Lumen output  
Max. 570 Lm

Page 59



### Pan 2 Micro

Lumen output  
Max. 1500Lm

Page 53



### Venezia UGR<19

Lumen output  
Max. 4500Lm

Page 60



### Pan 2

Lumen output  
Max. 4000 Lm

Page 54



### Aries Micro

Lumen output  
Max. 955 Lm

Page 61



### Pan Max

Lumen output  
Max. 5000 Lm

Page 55



### Aries Mini

Lumen output  
Max. 1500 Lm

Page 63



### Multi Down

Lumen output  
Max. 5000 Lm

Page 56



### Aries Max

Lumen output  
Max. 3500 Lm

Page 64



### Ariel Tri-Color

Lumen output  
Max. 3150 Lm

Page 66



### Ariel UGR<19

Lumen output  
Max. 3200 Lm

Page 67



### Ariel Universal

Lumen output  
Max. 1650 Lm

Page 69



### Ariel Universal Square

Lumen output  
Max. 1800 Lm

Page 70

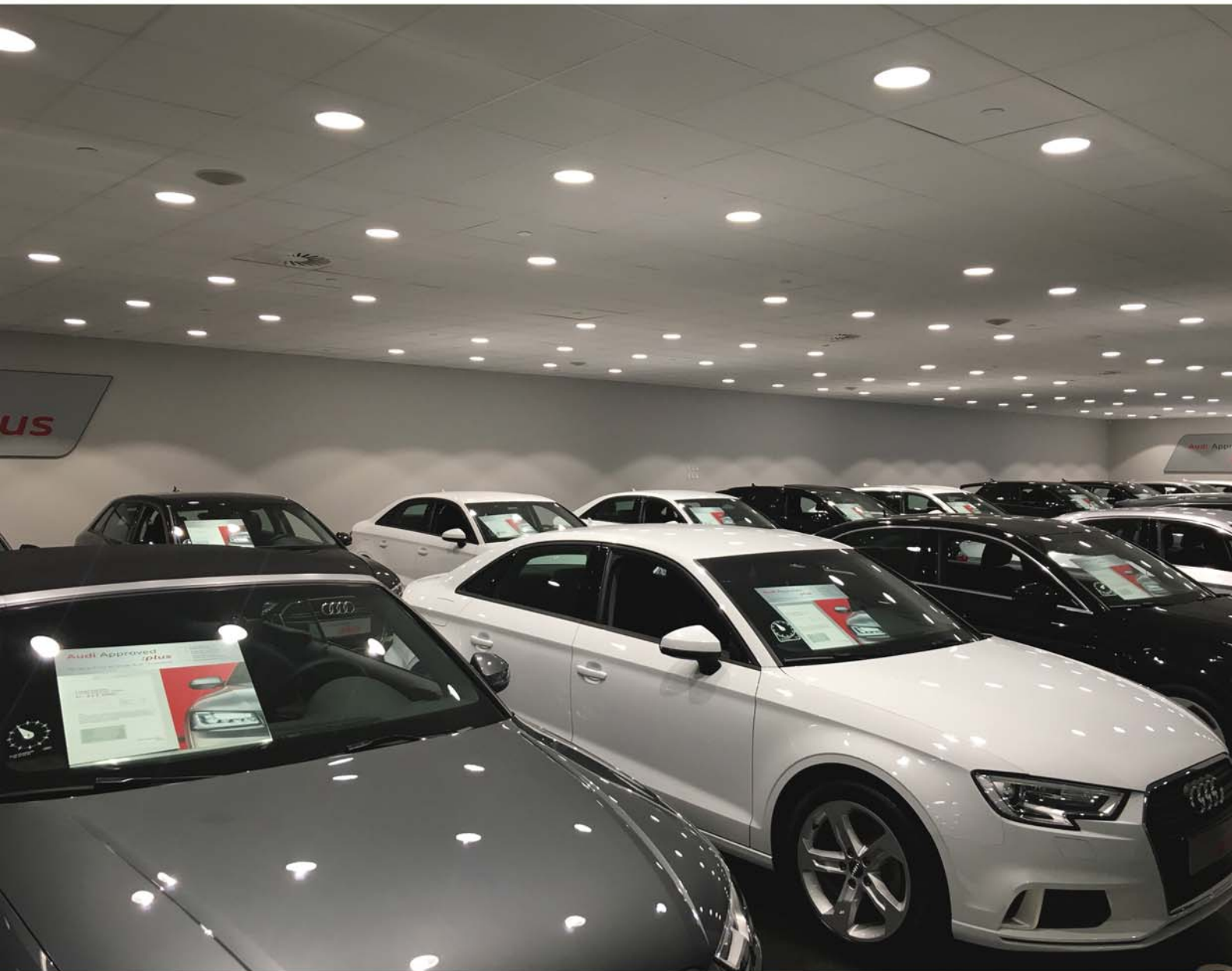



# Rhea Micro

LED DOWNLIGHT

## DESCRIPTION

Recessed spotlight designed for professional shop lighting. Available for LED  
 Quality reflector made of 99,9% pure aluminium.  
 Housing made out of die cast aluminium.  
 Philips SLM G7 slim system allow to produce fixture of homogenous lighting performance and high-efficiency natural looking light. Also with using high efficiency reflector, it can be performed in various beam angles.

Driver: Philips

Certificates: CE/ETL/CCC

Beam angle 24°

Colors: White/black/silver



|     |                  |                |                          |              |           |       |          |
|-----|------------------|----------------|--------------------------|--------------|-----------|-------|----------|
| LED | 5 YEARS WARRANTY | CE             | 50000h                   | L 80<br>B 50 | MacAdam 3 | IP 20 | Hg 0.0mg |
| 30° | 105mm Cutout     | ON OFF >100000 | 80% <math>\leq 1S</math> |              |           |       |          |

## PHOTOMETRIC CURVE

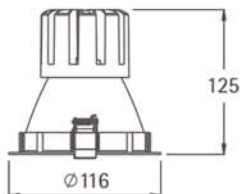
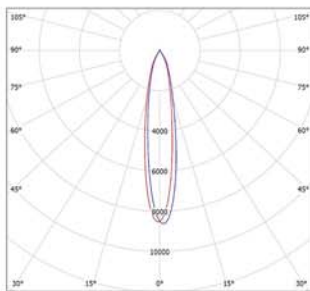

## AREA OF USE

Display windows, shops and other public places

## CAN BE DELIVERED WITH:

- 2700K
- 4000K
- 5000K
- Food COB
- Meat COB

| TYPE  | CRI    | LIGHT OUT | POWER | COLOR TEMP |
|-------|--------|-----------|-------|------------|
| 20100 | >80 Ra | 2000 lm   | 11 W  | 3000K      |
| 20100 | >80 Ra | 3000 lm   | 20 W  | 3000K      |
| 20100 | >90 Ra | 2000 lm   | 16 W  | 3000K      |

## DESCRIPTION

Recessed spotlight designed for professional shop lighting. Available for LED  
 Quality reflector made of 99,9% pure aluminium.  
 Housing made out of die cast aluminium.  
 Philips SLM G7 slim system allow to produce fixture of homogenous lighting performance and high-efficiency natural looking light. Also with using high efficiency reflector, it can be performed in various beam angles.

Driver: Philips

Certificates: CE/ETL/CCC

Beam angle 24°/36°/60°

Colors: White/black/silver



|     |                  |    |        |              |              |                   |             |
|-----|------------------|----|--------|--------------|--------------|-------------------|-------------|
| LED | 5 YEARS WARRANTY | CE | 50000h | L 70<br>B 50 | MacAdam<br>3 | IP<br>20          | Hg<br>0.0mg |
|     |                  |    |        | 80°          | 180mm Cutout | ON OFF<br>>100000 | 80%<br>≤1S  |

## PHOTOMETRIC CURVE

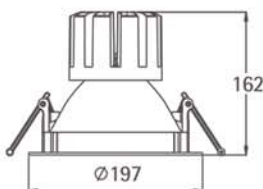
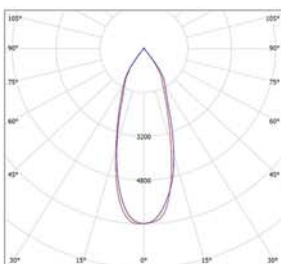

## AREA OF USE

Display windows, shops and other public places

## CAN BE DELIVERED WITH:

- 2700K
- 4000K
- 5000K
- Food COB
- Meat COB

| TYPE  | CRI    | LIGHT OUT | POWER | COLOR TEMP |
|-------|--------|-----------|-------|------------|
| 20200 | >80 Ra | 2000 lm   | 11 W  | 3000K      |
| 20200 | >80 Ra | 3000 lm   | 20 W  | 3000K      |
| 20200 | >80 Ra | 3500 lm   | 24 W  | 3000K      |
| 20200 | >80 Ra | 4000 lm   | 27 W  | 3000K      |
| 20200 | >80 Ra | 4500 lm   | 31 W  | 3000K      |
| 20200 | >80 Ra | 5000 lm   | 37 W  | 3000K      |
| 20200 | >90 Ra | 2000 lm   | 16 W  | 3000K      |
| 20200 | >90 Ra | 3000 lm   | 24 W  | 3000K      |
| 20200 | >90 Ra | 3500 lm   | 27 W  | 3000K      |
| 20200 | >90 Ra | 4000 lm   | 31 W  | 3000K      |
| 20200 | >90 Ra | 4500 lm   | 37 W  | 3000K      |





# Pan 2 Micro

LED DOWNLIGHT

## DESCRIPTION

Recessed spotlight designed for professional shop lighting. Available for LED  
 Quality reflector made of 99,9% pure aluminium.  
 Housing made out of die cast aluminium.  
 Philips SLM G7 slim system allow to produce fixture of homogenous lighting performance and high-efficiency natural looking light. Also with using high efficiency reflector, it can be performed in various beam angles.

Driver: Philips

Certificates: CE/ETL/CCC

Beam angle 16°/24°/36°

Colors: White/black/silver



|                     |                  |     |                 |                   |            |       |          |
|---------------------|------------------|-----|-----------------|-------------------|------------|-------|----------|
| LED                 | 5 YEARS WARRANTY | CE  | 50000h          | L 70<br>B 50      | MacAdam 3  | IP 20 | Hg 0.0mg |
| 200-240V<br>50/60Hz | 355°             | 50° | 102mm<br>Cutout | ON OFF<br>>100000 | 80%<br>≤1S |       |          |

## PHOTOMETRIC CURVE

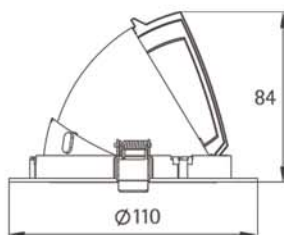
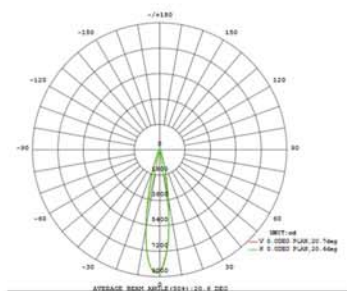

## AREA OF USE

Display windows, shops and other public places

## CAN BE DELIVERED WITH:

- 2700K
- 4000K
- 5000K
- Food COB
- Meat COB

| TYPE  | CRI    | LIGHT OUT | POWER | COLOR TEMP |
|-------|--------|-----------|-------|------------|
| 20300 | >80 Ra | 1500 lm   | 8 W   | 3000K      |
| 20300 | >90 Ra | 1500 lm   | 10 W  | 3000K      |

**Pan 2**

LED DOWNLIGHT

**DESCRIPTION**

Recessed spotlight designed for professional shop lighting. Available for LED  
 Quality reflector made of 99,9% pure aluminium.  
 Housing made out of die cast aluminium.  
 Philips SLM G7 slim system allow to produce fixture of homogenous lighting performance and high-efficiency natural looking light. Also with using high efficiency reflector, it can be performed in various beam angles.

Driver: Philips

Certificates: CE/ETL/CCC

Beam angle 12°/24°/36°/50°

Colors: White/black/silver



|                     |                         |           |                 |                   |              |          |             |
|---------------------|-------------------------|-----------|-----------------|-------------------|--------------|----------|-------------|
| <b>LED</b>          | <b>5 YEARS WARRANTY</b> | <b>CE</b> | 50000h          | L 70<br>B 50      | MacAdam<br>3 | IP<br>20 | Hg<br>0.0mg |
| 200-240V<br>50/60Hz | 355°                    | 50°       | 152mm<br>Cutout | ON OFF<br>>100000 | 80%<br>≤1S   |          |             |

**PHOTOMETRIC CURVE**

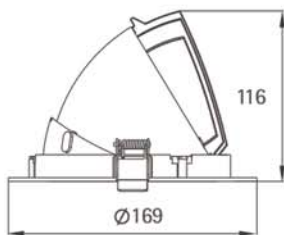
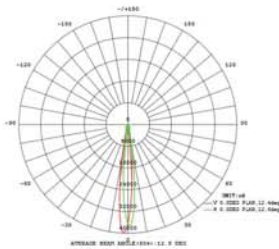

**AREA OF USE**

Display windows, shops and other public places

**CAN BE DELIVERED WITH:**

- 2700K
- 4000K
- 5000K
- Food COB
- Meat COB

| TYPE  | CRI    | LIGHT OUT | POWER | COLOR TEMP |
|-------|--------|-----------|-------|------------|
| 20400 | >80 Ra | 2000 lm   | 11 W  | 3000K      |
| 20400 | >80 Ra | 3000 lm   | 20 W  | 3000K      |
| 20400 | >80 Ra | 3500 lm   | 24 W  | 3000K      |
| 20400 | >80 Ra | 4000 lm   | 27 W  | 3000K      |
| 20400 | >90 Ra | 2000 lm   | 16 W  | 3000K      |
| 20400 | >90 Ra | 3000 lm   | 24 W  | 3000K      |
| 20400 | >90 Ra | 3500 lm   | 27 W  | 3000K      |

## DESCRIPTION

Recessed spotlight designed for professional shop lighting. Available for LED  
 Quality reflector made of 99,9% pure aluminium.  
 Housing made out of die cast aluminium.  
 Philips SLM G7 slim system allow to produce fixture of homogenous lighting performance and high-efficiency natural looking light. Also with using high efficiency reflector, it can be performed in various beam angles.

Driver: Philips

Certificates: CE/ETL/CCC

Beam angle 16°/24°/36°/50°

Colors: White/black/silver

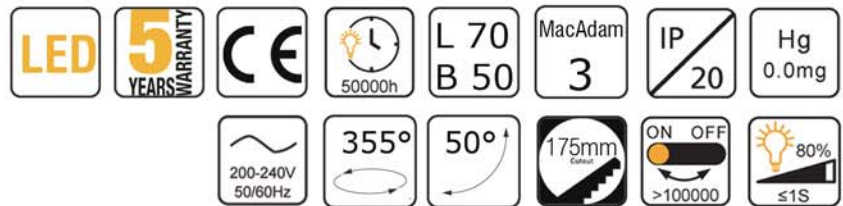

## PHOTOMETRIC CURVE

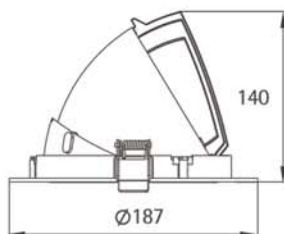
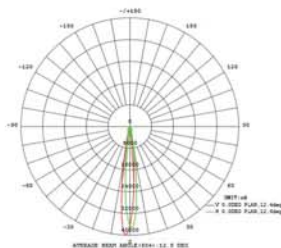

## AREA OF USE

Display windows, shops and other public places

## CAN BE DELIVERED WITH:

- 2700K
- 4000K
- 5000K
- Food COB
- Meat COB

| TYPE  | CRI    | LIGHT OUT | POWER | COLOR TEMP |
|-------|--------|-----------|-------|------------|
| 20500 | >80 Ra | 3000 lm   | 20 W  | 3000K      |
| 20500 | >80 Ra | 3500 lm   | 24 W  | 3000K      |
| 20500 | >80 Ra | 4000 lm   | 27 W  | 3000K      |
| 20500 | >80 Ra | 4500 lm   | 31 W  | 3000K      |
| 20500 | >80 Ra | 5000 lm   | 37 W  | 3000K      |
| 20500 | >90 Ra | 3000 lm   | 24 W  | 3000K      |
| 20500 | >90 Ra | 3500 lm   | 27 W  | 3000K      |
| 20500 | >90 Ra | 4000 lm   | 31W   | 3000K      |
| 20500 | >90 Ra | 4500 lm   | 37 W  | 3000K      |
| 20500 | >90 Ra | 5000 lm   | 38 W  | 3000K      |



# Multi Down

## DESCRIPTION

Recessed spotlight designed for professional shop lighting.

Quality reflector made of 99,9% pure aluminium.  
Housing made out of die cast aluminium.  
Philips SLM G7 slim system allow to produce fixture of homogenous lighting performance and high-efficiency natural looking light.

Driver: Philips

Certificates: CE/ETL/CCC

Beam angle 15°/24°/36°

Colors: White/black/silver



|            |                         |                      |                      |                   |              |          |             |
|------------|-------------------------|----------------------|----------------------|-------------------|--------------|----------|-------------|
| <b>LED</b> | <b>5 YEARS WARRANTY</b> | <b>CE</b>            | 50000h               | L 70<br>B 50      | MacAdam<br>3 | IP<br>20 | Hg<br>0.0mg |
| 30°        | 140x470 mm<br>Cutout    | 140x310 mm<br>Cutout | 140x140 mm<br>Cutout | ON OFF<br>>100000 | 80%<br>≤1S   |          |             |
|            | Triple                  | Double               | Single               |                   |              |          |             |

## PHOTOMETRIC CURVE

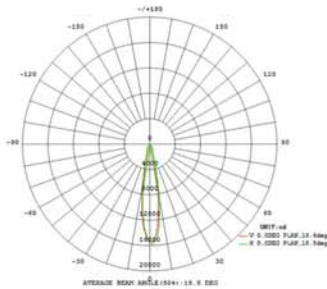

|  | A   | B     | C                   |
|--|-----|-------|---------------------|
|  | 207 | 111-2 | 163 135 163/326/489 |

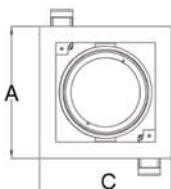
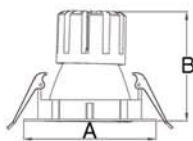

## AREA OF USE

Display windows, shops and other public places

## CAN BE DELIVERED WITH:

- 2700K
- 4000K
- 5000K
- Food COB
- Meat COB

| TYPE  | CRI    | LIGHT OUT | POWER | COLOR TEMP |
|-------|--------|-----------|-------|------------|
| 20600 | >80 Ra | 2000 lm   | 11 W  | 3000K      |
| 20600 | >80 Ra | 3000 lm   | 20 W  | 3000K      |
| 20600 | >80 Ra | 3500 lm   | 24 W  | 3000K      |
| 20600 | >80 Ra | 4500 lm   | 31W   | 3000K      |
| 20600 | >80 Ra | 5000 lm   | 37 W  | 3000K      |
| 20600 | >90 Ra | 2000 lm   | 16 W  | 3000K      |
| 20600 | >90 Ra | 3000 lm   | 24 W  | 3000K      |
| 20600 | >90 Ra | 3500 lm   | 27 W  | 3000K      |
| 20600 | >90 Ra | 4500 lm   | 37 W  | 3000K      |





## DESCRIPTION

This downlight is a gyro design, suitable for covering with insulation material directly. Adopt high lumen COB light source, ADC12 aluminium housing provides a great heat dissipation. The luminaire is tilted 23° in all directions(360°), perfectly meet the demands of different lighting angle. Also available as Dim-to-Warm version (2000K-3000K)

Driver: Philips

Certificates: CE/ETL/CCC

Beam angle 12°/24°/36°/60°

Colors: White/black/silver/  
brushed-nickel

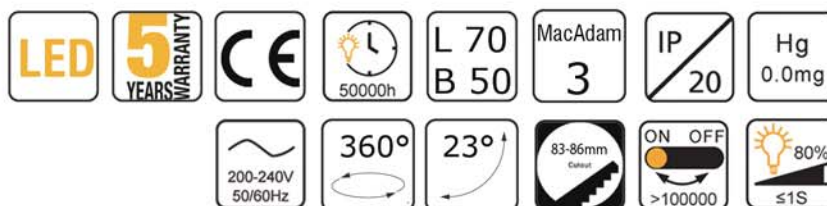

## AREA OF USE

Office, supermarket, shop, school, hotel, public areas, stairway, lobby, reception, corridors etc.

## CAN BE DELIVERED WITH:

- 2700K
- 3000K
- 4000K
- 5000K
- Dim-to-Warm (2000K-3000K)

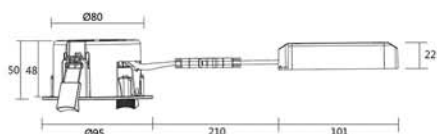

| TYPE  | CRI    | LIGHT OUT | POWER | COLOR TEMP |
|-------|--------|-----------|-------|------------|
| 20700 | >80 Ra | 432 lm    | 8 W   | 3000K      |
| 20720 | >90 Ra | 445 lm    | 8 W   | 3000K      |
| 20740 | >80 Ra | 738 lm    | 8 W   | 4000K      |
| 20760 | >90 Ra | 864 lm    | 8 W   | 4000K      |



## DESCRIPTION

Milano downlights are designed for low mounting depth.  
 With replaceable driver, Loop-in/out design makes the installation and maintenance easier.  
 IP54 waterproof  
 Easier installation for low mounting depth  
 Easy installation with push terminals  
 Replaceable driver

Certificates: CE/TUV/GS

Color: White/brush nickel



## AREA OF USE

Office, supermarket, shop, school, hotel, for public areas, such as stairway, lobby, reception, corridors etc.

## CAN BE DELIVERED WITH:

2700K  
 4000K  
 5000K

|       | A  | B  | C  | D  |
|-------|----|----|----|----|
| 20900 | 80 | 33 | 32 | 68 |
| 20910 | 80 | 33 | 30 | 68 |
| 20920 | 95 | 44 | 40 | 68 |
| 20930 | 95 | 44 | 40 | 68 |

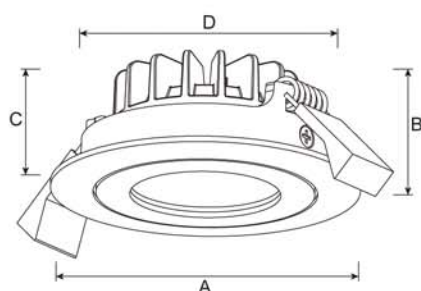

| TYPE  | CRI    | LIGHT OUT | POWER | COLOR TEMP |
|-------|--------|-----------|-------|------------|
| 20900 | >80 Ra | 450 lm    | 6W    | 3000K      |
| 20910 | >80 Ra | 480 lm    | 6W    | 3000K      |
| 20920 | >80 Ra | 670 lm    | 8W    | 3000K      |
| 20930 | >80 Ra | 835 lm    | 10W   | 3000K      |

# Venezia UGR<19

## DESCRIPTION

DL178 downlight with traditional deep reflector (UGR < 19) that provides perfect combination of high lighting efficiency, comfortable lighting and humanization design, without compromising on light performance (color rendering and color uniformity) It offers a wide choice of options for creating the desired ambience.

Available with Triac dim, 0-10V dim, DALI dim  
No UV/IR light

Certificates: CE/SAA/RoHS

Beam angle: 36°

Colors: White



## PHOTOMETRIC CURVE

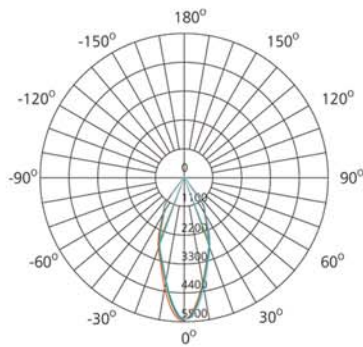

|       | A    | B  |
|-------|------|----|
| 21100 | Ø95  | 54 |
| 21120 | Ø110 | 54 |
| 21140 | Ø145 | 78 |
| 21160 | Ø172 | 90 |
| 21180 | Ø228 | 99 |

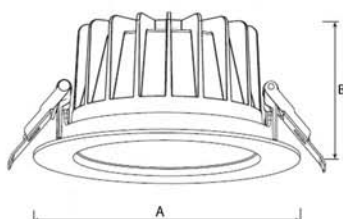

|          |                  |                  |                |                |                  |                  |                  |
|----------|------------------|------------------|----------------|----------------|------------------|------------------|------------------|
| LED      | 5 YEARS WARRANTY | CE               | 50000h         | L 70<br>B 50   | MacAdam 3        | IP 54            | Hg 0.0mg         |
| Dimmable | UGR <19          | Grounding symbol | 82-88mm Cutout | 90-95mm Cutout | 125-135mm Cutout | 150-165mm Cutout | 200-210mm Cutout |
| IK 06    | ON OFF >100000   | 200-240V 50/60Hz | 3"A            | 3"B            | 4"               | 6"               | 8"               |

## AREA OF USE

Display windows, shops and other public places

## CAN BE DELIVERED WITH:

2700K  
4000K  
5000K

| TYPE  | CRI    | LIGHT OUT | POWER    | COLOR TEMP. |
|-------|--------|-----------|----------|-------------|
| 21100 | >80 Ra | 100 lm/W  | Max 10 W | 3000K       |
| 21120 | >80 Ra | 100 lm/W  | Max 13 W | 3000K       |
| 21140 | >80 Ra | 100 lm/W  | Max 25 W | 3000K       |
| 21160 | >80 Ra | 100 lm/W  | Max 35 W | 3000K       |
| 21180 | >80 Ra | 100 lm/W  | Max 45 W | 3000K       |

## DESCRIPTION

Aries Micro downlight is unique designed with reflector and Citizen COB high power LED chip.

ADC12 Aluminum profile provides excellent thermal dissipation.

Short heatsink designed for any ceiling installations.

Isolated driver solution both in dimmable and non-dimmable version achieves great dimming compatibility with worldwide brand dimmers. Up to 70% energy saving compared to standard CFL.

Certificates: CE/ETL/CCC

Beam angle 60°

Colors: White/black/grey



## PHOTOMETRIC CURVE

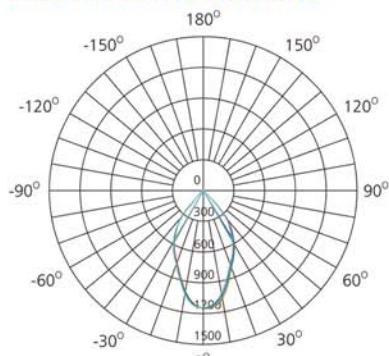

|     | A    | B  | C  | D   |
|-----|------|----|----|-----|
| 203 | Ø110 | 53 | 16 | Ø88 |

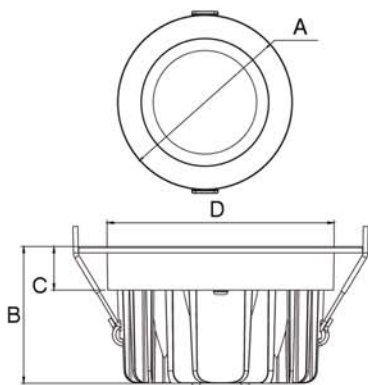

## AREA OF USE

Shop, office, supermarket, shop, school, hotel, etchops and other public places. For indoor use IP20 and for outdoor use IP44

## CAN BE DELIVERED WITH:

- 2700K
- 3000K
- 4000K
- 5000K

| TYPE  | CRI    | LIGHT OUT | POWER | COLOR TEMP |
|-------|--------|-----------|-------|------------|
| 21300 | >80 Ra | 840 lm    | 13 W  | 2700K      |
| 21301 | >80 Ra | 890 lm    | 13 W  | 3000K      |
| 21302 | >80 Ra | 945 lm    | 13 W  | 4000K      |
| 21303 | >80 Ra | 955 lm    | 13 W  | 5000K      |
| 21304 | >90 Ra | 780 lm    | 13 W  | 2700K      |
| 21305 | >90 Ra | 830 lm    | 13 W  | 3000K      |
| 21306 | >90 Ra | 880 lm    | 13 W  | 4000K      |
| 21307 | >90 Ra | 890 lm    | 13 W  | 5000K      |





## DESCRIPTION

Aries Mini downlight is unique designed with reflector and Citizen COB high power LED chip.  
 ADC12 Aluminum profile provides excellent thermal dissipation.  
 Short heatsink designed for any ceiling installations.  
 Isolated driver solution both in dimmable and non-dimmable version achieves great dimming compatibility with worldwide brand dimmers.  
 Up to 70% energy saving compared to standard CFL.

Certificates: CE/ETL/CCC

Beam angle 24°/45°/60°

Colors: White/black/grey



|              |                  |         |                 |                |           |       |          |
|--------------|------------------|---------|-----------------|----------------|-----------|-------|----------|
| LED          | 5 YEARS WARRANTY | CE      | 40.000h         | L 70<br>B 50   | MacAdam 3 | IP 44 | Hg 0.0mg |
| 120mm Cutout | ON OFF >100000   | 80% ≤1S | 90-277V 50/60Hz | 1-10V Dimmable |           |       |          |

## PHOTOMETRIC CURVE

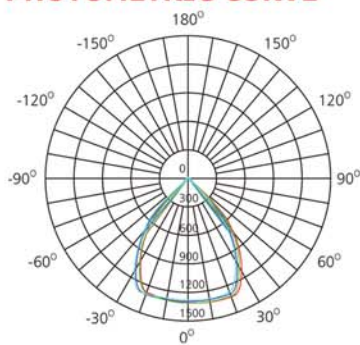

|     | A    | B  | C  | D    |
|-----|------|----|----|------|
| 214 | Ø145 | 65 | 17 | Ø118 |

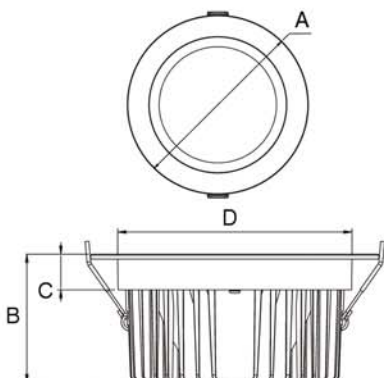

## AREA OF USE

Shop, office, supermarket, shop, school, hotel, etchops and other public places. For indoor use IP20 and for outdoor use IP44

## CAN BE DELIVERED WITH:

- 2700K
- 3000K
- 4000K
- 5000K

| TYPE  | CRI    | LIGHT OUT | POWER | COLOR TEMP |
|-------|--------|-----------|-------|------------|
| 21400 | >80 Ra | 1300 lm   | 18 W  | 2700K      |
| 21401 | >80 Ra | 1350 lm   | 18 W  | 3000K      |
| 21402 | >80 Ra | 1500 lm   | 18 W  | 4000K      |
| 21403 | >80 Ra | 1450 lm   | 18 W  | 5000K      |
| 21404 | >90 Ra | 1250 lm   | 18 W  | 2700K      |
| 21405 | >90 Ra | 1300 lm   | 18 W  | 3000K      |
| 21406 | >90 Ra | 1480 lm   | 18 W  | 4000K      |
| 21407 | >90 Ra | 1420 lm   | 18 W  | 5000K      |

# Aries Max

LED DOWNLIGHT

## DESCRIPTION

Aries Max downlight is unique designed with reflector and Citizen COB high power LED chip.  
 ADC12 Aluminum profile provides excellent thermal dissipation.  
 Short heatsink designed for any ceiling installations.  
 Isolated driver solution both in dimmable and non-dimmable version achieves great dimming compatibility with worldwide brand dimmers.  
 Up to 70% energy saving compared to standard CFL.

Certificates: CE/ETL/CCC

Beam angle 36°/60°

Colors: White/black/grey



|            |                         |           |                 |                   |              |                    |                   |
|------------|-------------------------|-----------|-----------------|-------------------|--------------|--------------------|-------------------|
| <b>LED</b> | <b>5 YEARS WARRANTY</b> | <b>CE</b> | 40.000h         | L 70<br>B 50      | MacAdam<br>3 | IP<br>44           | Hg<br>0.0mg       |
|            |                         |           | 160mm<br>Cutout | ON OFF<br>>100000 | 80%<br>≤1S   | 90-277V<br>50/60Hz | 1-10V<br>Dimmable |

## PHOTOMETRIC CURVE

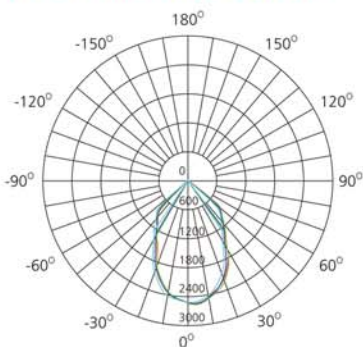

|     | A    | B  | C  | D    |
|-----|------|----|----|------|
| 215 | Ø190 | 75 | 18 | Ø158 |

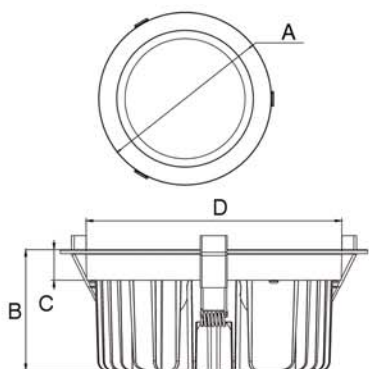

## AREA OF USE

Shop, office, supermarket, shop, school, hotel, etchops and other public places. For indoor use IP20 and for outdoor use IP44

## CAN BE DELIVERED WITH:

- 2700K
- 3000K
- 4000K
- 5000K

| TYPE  | CRI    | LIGHT OUT | POWER | COLOR TEMP |
|-------|--------|-----------|-------|------------|
| 21500 | >80 Ra | 3150 lm   | 35 W  | 2700K      |
| 21501 | >80 Ra | 3320 lm   | 35 W  | 3000K      |
| 21502 | >80 Ra | 3430 lm   | 35 W  | 4000K      |
| 21503 | >80 Ra | 3360 lm   | 35 W  | 5000K      |
| 21504 | >90 Ra | 3150 lm   | 35 W  | 2700K      |
| 21505 | >90 Ra | 3290 lm   | 35 W  | 3000K      |
| 21506 | >90 Ra | 3400 lm   | 35 W  | 4000K      |
| 21507 | >90 Ra | 3320 lm   | 35 W  | 5000K      |



*Cartier*

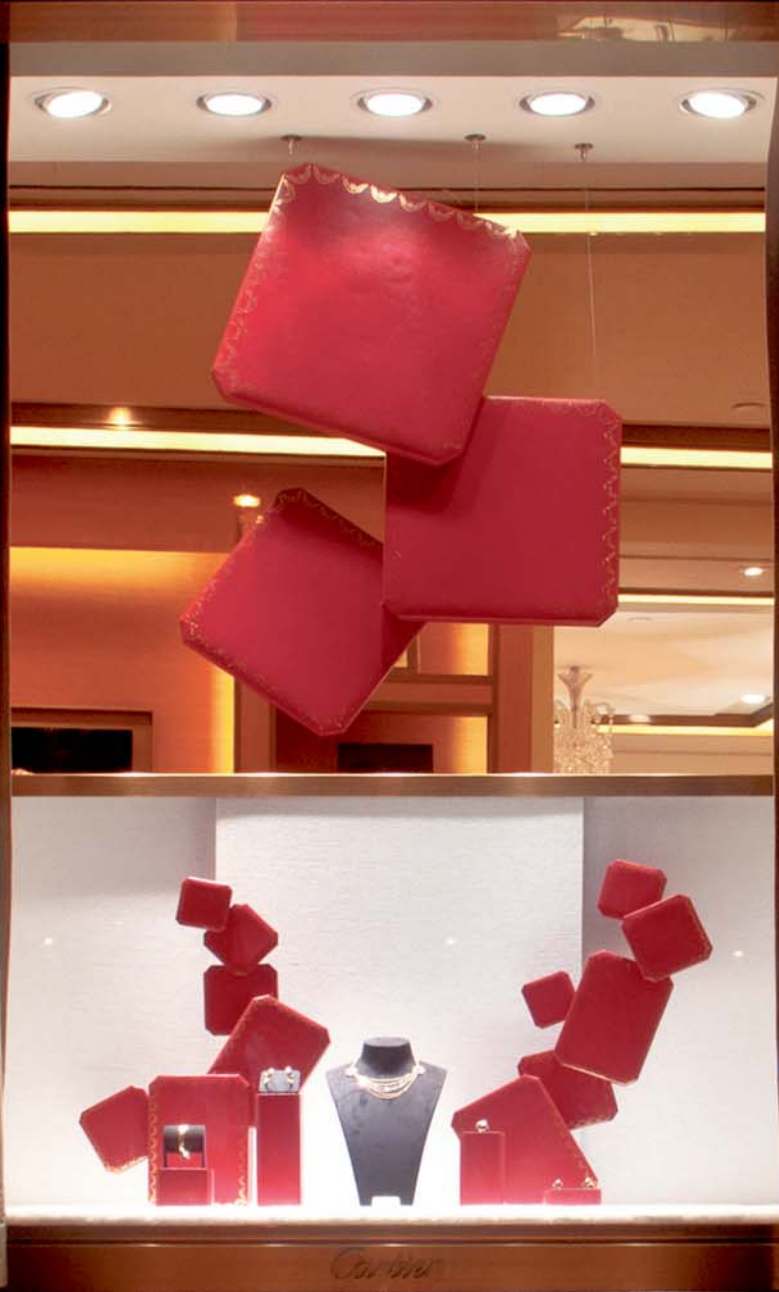

*Cartier*

# Ariel Tri-Color

LED DOWNLIGHT

## DESCRIPTION

Creating fantastic atmosphere by flexible CCT changing between warm white, natural white and day light, the color changing downlights are controlled by slide switch, which aims at reducing your stock by different color temperature and enables end users to choose suitable color for different applications freely. Once a color has been selected, you can also dim by triac dimmers, it is compatible with worldwide famous dimmers. 8~100% dimming range, smooth dimming effect and brightness changing, no flickering. Your ideal choice!  
Environment friendly, without Mercury or any other hazardous substances

Certificates: CE/SAA/RoHS

Beam angle: 90°

Colors: White

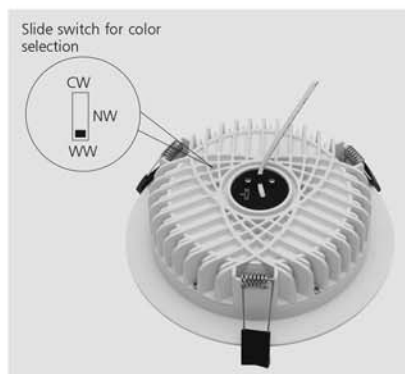

|          |                  |                  |         |                     |                |       |          |
|----------|------------------|------------------|---------|---------------------|----------------|-------|----------|
| LED      | 5 YEARS WARRANTY | CE               | 40000h  | L 70<br>B 50        | MacAdam 3      | IP 20 | Hg 0.0mg |
| Dimmable | 90°              | 200-210mm Cutout | UGR <19 | 200-240V<br>50/60Hz | ON OFF >100000 |       |          |

## AREA OF USE

Office, supermarket, shop, school, hotel, stairway, lobby, reception, corridors etc.

## CAN BE DELIVERED WITH:

2700K/4000K/5700K

|             | A    | B    | C  |
|-------------|------|------|----|
| 21260-21266 | Ø228 | Ø192 | 45 |

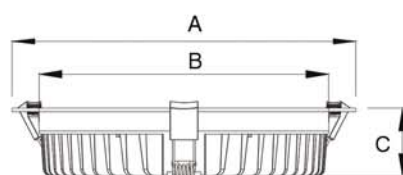

| TYPE  | CRI    | LIGHT OUT | POWER | COLOR TEMP |
|-------|--------|-----------|-------|------------|
| 21260 | >80 Ra | lm        | 10 W  | 2700K      |
| 21261 | >80 Ra | lm        | 13 W  | 2700K      |
| 21262 | >80 Ra | lm        | 18 W  | 2700K      |
| 21263 | >80 Ra | lm        | 25 W  | 2700K      |
| 21264 | >80 Ra | lm        | 25 W  | 2700K      |
| 21265 | >80 Ra | lm        | 35 W  | 2700K      |
| 21266 | >80 Ra | lm        | 30 W  | 2700K      |

## DESCRIPTION

Three size are optional: 13W, 25W and 35W  
 Two installation clips for each downlight makes installation easier  
 Up to 70% energy saving compared to standard CFL  
 Available with Triac dim, 0-10V dim, DALI dim  
 No UV/IR light

Certificates: CE/SAA/RoHS

Beam angle:  
 13W: 45°  
 25W: 36°  
 35W: 45°

Colors: White



## PHOTOMETRIC CURVE

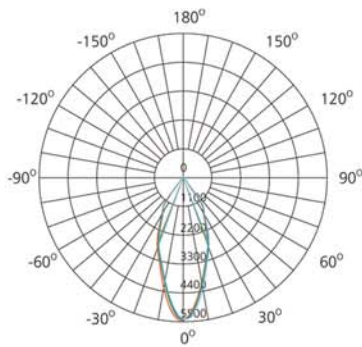

|       | A    | B   |
|-------|------|-----|
| 21200 | Ø110 | 100 |
| 21220 | Ø190 | 127 |
| 21240 | Ø230 | 140 |

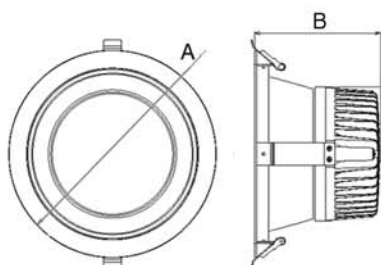

|          |                    |                     |                     |              |                     |                   |             |
|----------|--------------------|---------------------|---------------------|--------------|---------------------|-------------------|-------------|
| LED      | 5 YEARS WARRANTY   | CE                  | 50000h              | L 70<br>B 50 | MacAdam<br>3        | IP<br>20          | Hg<br>0.0mg |
| Dimmable | 90-100mm<br>Cutout | 165-180mm<br>Cutout | 205-220mm<br>Cutout | UGR<br><19   | 200-240V<br>50/60Hz | ON OFF<br>>100000 |             |
|          | 13W                | 25W                 | 35W                 |              |                     |                   |             |

## AREA OF USE

Display windows, shops and other public places

## CAN BE DELIVERED WITH:

2700K  
 4000K  
 5000K

| TYPE  | CRI    | LIGHT OUT | POWER | COLOR TEMP |
|-------|--------|-----------|-------|------------|
| 21200 | >80 Ra | 1050 lm   | 13 W  | 3000K      |
| 21220 | >80 Ra | 2450 lm   | 25 W  | 3000K      |
| 21240 | >80 Ra | 3200 lm   | 35 W  | 3000K      |





**DESCRIPTION**

This downlight featured with adjustable cutout size. Adopt high lumen SMD LED and edge lighting design with even light output. AL1060 Aluminium profile provides excellent thermal dissipation. Super slim with internal driver, can be widely used in various application. Recessed and surface mounted installation optional.

Adjustable cutout size from 65mm to 205mm for recessed installation, more choice for replacement work.

Super slim with internal driver.

Interchangeable CCT(3000/4000/5700K) with slide switch.

Interchangeable power.

Recessed and surface mounted installation.

Certificates: CE/SAA/TÜV/RoHS

Colors: White

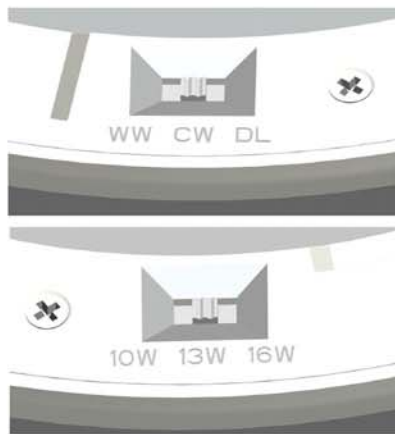

|            |                  |                  |                    |              |           |       |          |
|------------|------------------|------------------|--------------------|--------------|-----------|-------|----------|
| LED        | 5 YEARS WARRANTY | CE               | 50000h             | L 80<br>B 10 | MacAdam 3 | IP 20 | Hg 0.0mg |
| 80%<br>≤1S | Grounding symbol | ON OFF<br>>50000 | 90-277V<br>50/60Hz | 120°         |           |       |          |

**AREA OF USE**

Office, supermarket, shop, school, hotel, stairway, lobby, reception, corridors

|       | A    | B  | C   | D      |
|-------|------|----|-----|--------|
| 60400 | Ø235 | 16 | 175 | 65-205 |

| TYPE  | CRI    | LIGHT OUT   | POWER      | COLOR TEMP |
|-------|--------|-------------|------------|------------|
| 21600 | >80 Ra | 950-1650 lm | 10/13/16 W | 3/4/5700 K |

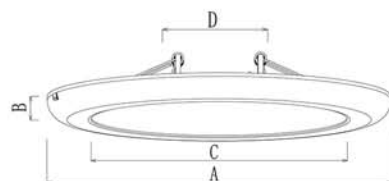

# Ariel Universal Square

LED DOWNLIGHT

## DESCRIPTION

Ariel Universal Square down-light with SMD LED  
 Aluminium lamp body  
 AC to DC internal driver,  
 square shape.  
 Recessed and surface mounted  
 installation are available.  
 Cutout size is adjustable from  
 65 to 205mm for recessed  
 installation.  
 CCT and power is switchable  
 for choise.

Certificates: CE/SAA/RoHS

Colors: White

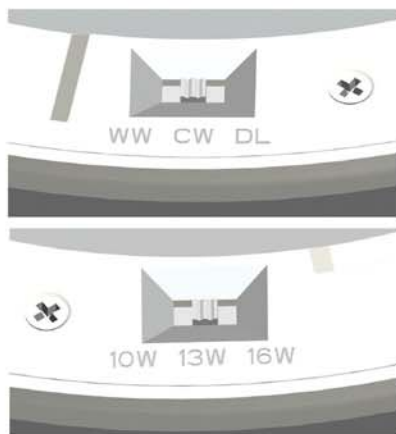

|       | A   | B   | B  |
|-------|-----|-----|----|
| 21620 | 235 | 235 | 16 |

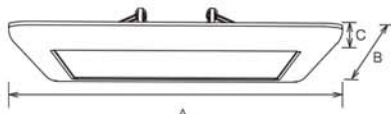

|     |                  |    |        |              |           |                            |                |                  |      |
|-----|------------------|----|--------|--------------|-----------|----------------------------|----------------|------------------|------|
| LED | 5 YEARS WARRANTY | CE | 50000h | L 70<br>B 50 | MacAdam 3 | IP 54                      | Hg 0.0mg       |                  |      |
|     |                  |    |        |              | DIM       | adjustable 65-205mm Cutout | ON OFF >100000 | 200-240V 50/60Hz | 120° |

## AREA OF USE

Office, supermarket, shop, school, hotel, stairway, lobby, reception, corridors etc.

## CAN BE DELIVERED WITH:

3CCT/3000K/4000K/5000K

| TYPE  | CRI    | POWER     | LIGHT OUT | COLOR TEMP |
|-------|--------|-----------|-----------|------------|
| 21620 | >80 Ra | 10/13/16W | 1800Lm    | 3/4/5000K  |





**DELUXE PANEL**  
Tri-color  
110-120 Lm/W  
30x30cm

Page 73



**DELUXE PANEL**  
Tri-color  
110-120 Lm/W  
60x120cm

Page 79



**DELUXE PANEL**  
Tri-color  
110-120 Lm/W  
30x60cm

Page 74



**PREMIUM PANEL**  
Tri-color  
140-150Lm/W  
30x30cm/30x60cm  
30x120cm/60x60cm  
60x120cm/62x62cm

Page 80



**DELUXE PANEL**  
Tri-color  
110-120 Lm/W  
30x120cm

Page 76



**SP PANEL**  
110-120 Lm/W  
60x60cm

Page 82



**DELUXE PANEL**  
Tri-color  
110-120 Lm/W  
60x60cm

Page 77



**Omega Panel**  
Easy Air Sensor

Page 83



**Accessories for panel**

Page 84



## DESCRIPTION

Extra thin aluminum frame  
10mm  
110-120 Lm/W  
White flat frame

Installation:  
Recessed / surface mounting /  
suspension installation

1-10V dimming or Non-dim-  
mable

Color switch: 3000/4000/5000K

Certificates: CE/TÜV/SAA/RoHS

Colors: White

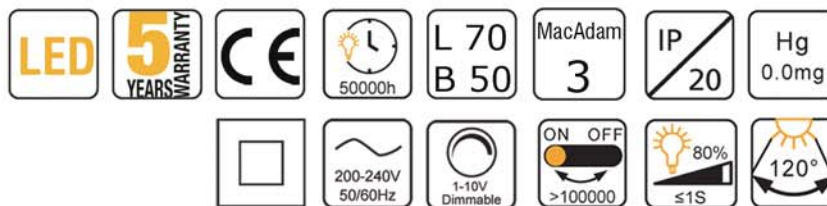

## PHOTOMETRIC CURVE

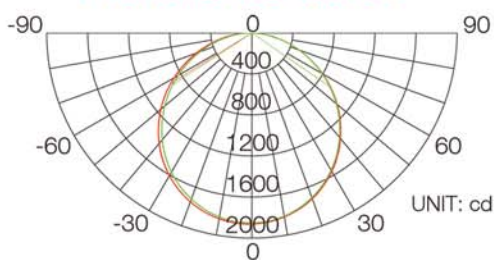

## AREA OF USE

Shops and other public places

|     | A   | B   | C  |
|-----|-----|-----|----|
| 301 | 295 | 295 | 10 |

| TYPE  | CRI    | LIGHT OUT | POWER | COLOR TEMP | UGR |
|-------|--------|-----------|-------|------------|-----|
| 30110 | >80 Ra | 1750 lm   | 16 W  | 3/4/5000K  | >19 |
| 30120 | >80 Ra | 1900 lm   | 16 W  | 3/4/5000K  | <19 |

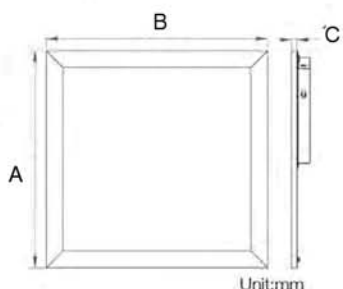



### DESCRIPTION

Extra thin aluminum frame  
10mm  
110-120 Lm/W  
White flat frame

Installation:  
Recessed / surface mounting /  
suspension installation

1-10V dimming or Non-dim-  
mable

Color switch: 3000/4000/5000K

Certificates: CE/TÜV/SAA/RoHS

Colors: White

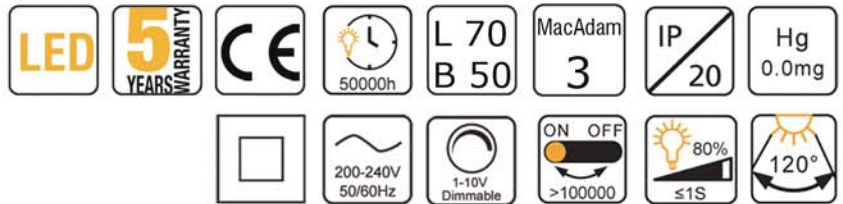
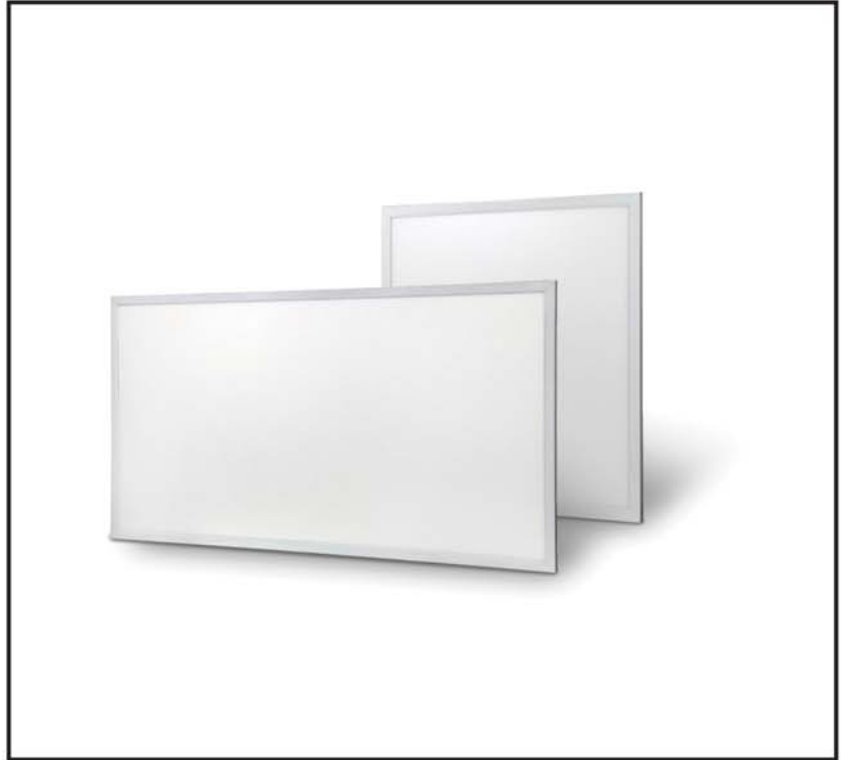

### PHOTOMETRIC CURVE

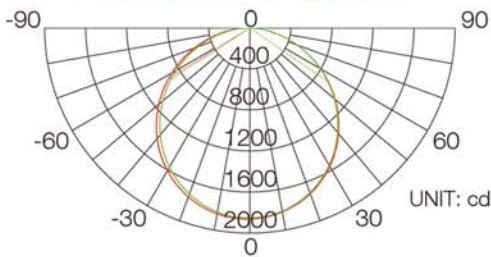

### AREA OF USE

Shops and other public places

|     | A   | B   | C  |
|-----|-----|-----|----|
| 302 | 295 | 595 | 10 |

| TYPE  | CRI    | LIGHT OUT | POWER | COLOR TEMP | UGR |
|-------|--------|-----------|-------|------------|-----|
| 30210 | >80 Ra | 2450 lm   | 20 W  | 3/4/5000K  | >19 |
| 30220 | >80 Ra | 2650 lm   | 20 W  | 3/4/5000K  | <19 |

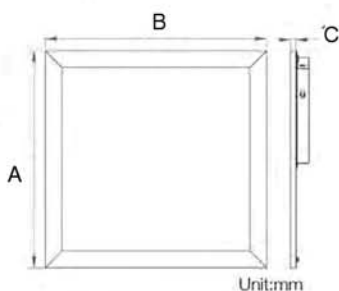



## DESCRIPTION

Extra thin aluminum frame  
10mm  
110-120 Lm/W  
White flat frame

Installation:  
Recessed / surface mounting /  
suspension installation

1-10V dimming or Non-dim-  
mable

Color switch: 3000/4000/5000K

Certificates: CE/TÜV/SAA/RoHS

Colors: White

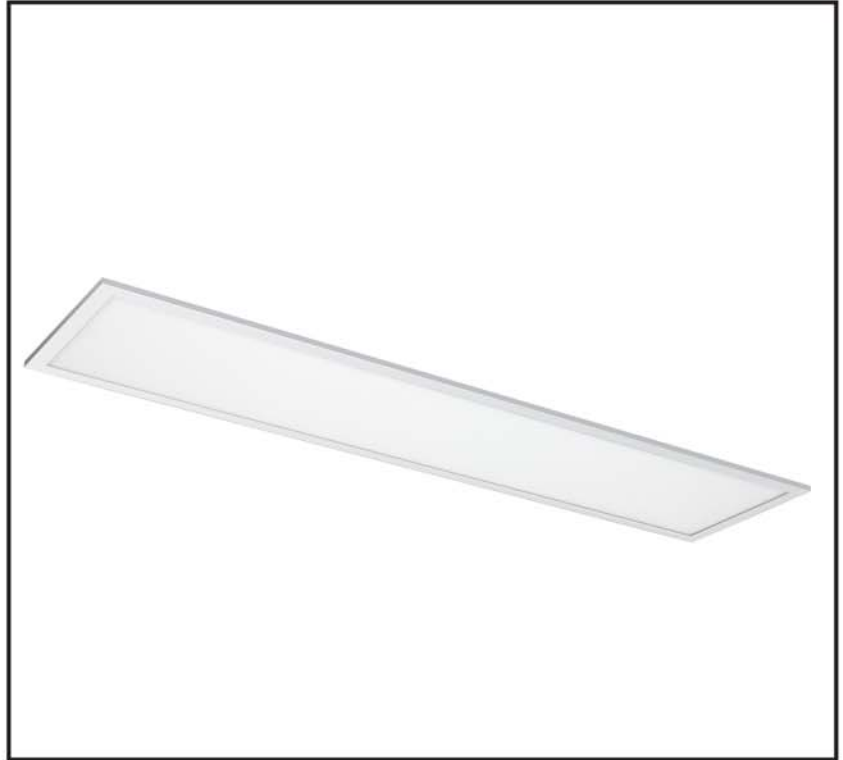

LED PANEL

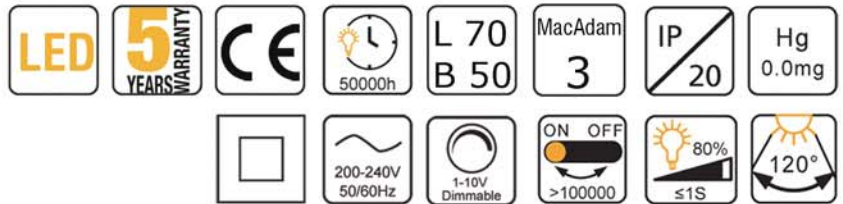

## PHOTOMETRIC CURVE

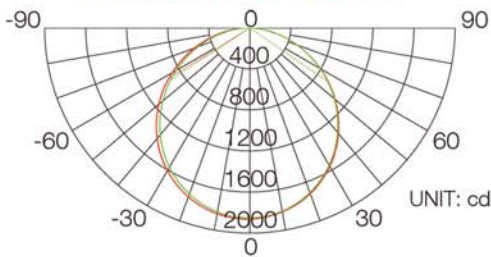

## AREA OF USE

Shops and other public places

|     | A    | B   | C  |
|-----|------|-----|----|
| 303 | 1195 | 295 | 10 |

| TYPE  | CRI    | LIGHT OUT | POWER | COLOR TEMP | UGR |
|-------|--------|-----------|-------|------------|-----|
| 30310 | >80 Ra | 3840 lm   | 32 W  | 3/4/5000K  | >19 |
| 30315 | >80 Ra | 4800 lm   | 40 W  | 3/4/5000K  | >19 |
| 30320 | >80 Ra | 3840 lm   | 32 W  | 3/4/5000K  | <19 |
| 30325 | >80 Ra | 4800 lm   | 40 W  | 3/4/5000K  | <19 |

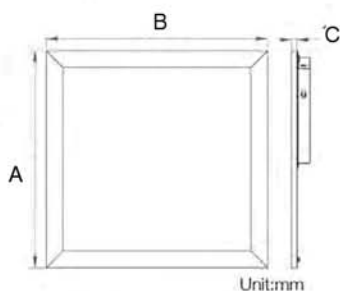



**DESCRIPTION**

Extra thin aluminum frame  
10mm  
110-120 Lm/W  
White flat frame

Installation:  
Recessed / surface mounting /  
suspension installation

1-10V dimming or Non-dim-  
mable

Color switch: 3000/4000/5000K

Certificates: CE/TÜV/SAA/RoHS

Colors: White

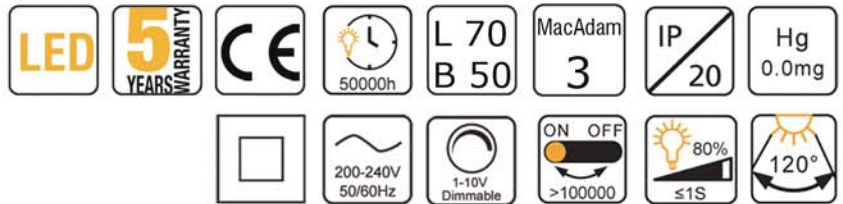

**PHOTOMETRIC CURVE**

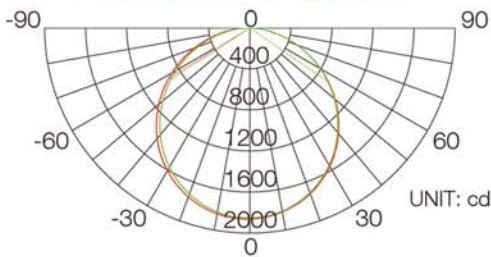

**AREA OF USE**

Shops and other public places

|     | A   | B   | C  |
|-----|-----|-----|----|
| 304 | 595 | 595 | 10 |

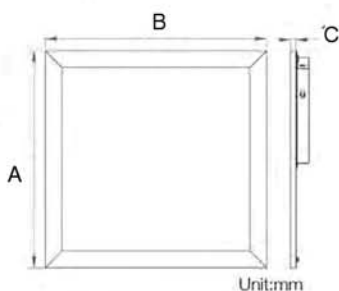

| TYPE  | CRI    | LIGHT OUT | POWER | COLOR TEMP | UGR |
|-------|--------|-----------|-------|------------|-----|
| 30410 | >80 Ra | 3840 lm   | 32 W  | 3/4/5000K  | >19 |
| 30415 | >80 Ra | 4800 lm   | 40 W  | 3/4/5000K  | >19 |
| 30420 | >80 Ra | 3840 lm   | 32 W  | 3/4/5000K  | <19 |
| 30425 | >80 Ra | 4800 lm   | 40 W  | 3/4/5000K  | <19 |



### DESCRIPTION

Extra thin aluminum frame  
10mm  
110-120 Lm/W  
White flat frame

Installation:  
Recessed / surface mounting /  
suspension installation

1-10V dimming or Non-dim-  
mable

Color switch: 3000/4000/5000K

Certificates: CE/TÜV/SAA/RoHS

Colors: White



|            |                         |           |                     |                   |                   |            |             |
|------------|-------------------------|-----------|---------------------|-------------------|-------------------|------------|-------------|
| <b>LED</b> | <b>5 YEARS WARRANTY</b> | <b>CE</b> | 50000h              | L 70<br>B 50      | MacAdam<br>3      | IP<br>20   | Hg<br>0.0mg |
|            |                         |           | 200-240V<br>50/60Hz | 1-10V<br>Dimmable | ON OFF<br>>100000 | 80%<br>≤1S | 120°        |

### PHOTOMETRIC CURVE

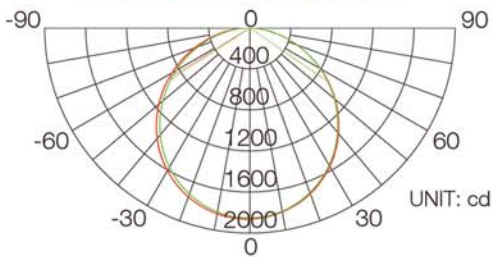

### AREA OF USE

Shops and other public places

|     | A    | B   | C  |
|-----|------|-----|----|
| 305 | 1195 | 595 | 10 |

| TYPE  | CRI    | LIGHT OUT | POWER | COLOR TEMP | UGR |
|-------|--------|-----------|-------|------------|-----|
| 30510 | >80 Ra | 7200 lm   | 60 W  | 3/4/5000K  | >19 |
| 30520 | >80 Ra | 7200 lm   | 60 W  | 3/4/5000K  | <19 |

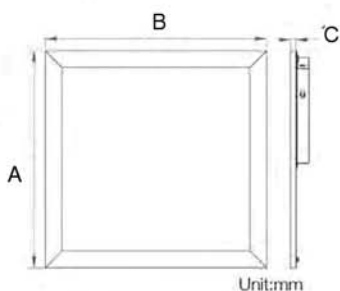



# Premium Paneler

LED PANEL

## DESCRIPTION

Extra thin aluminum frame  
10mm  
140-150 Lm/W  
White flat frame, can be delivered with silver frame.  
Installation:  
Recessed / surface mounting / suspension installation  
1-10V dimming or Non-dimmable  
Size: 30x30cm, 30x60cm  
30x120cm, 60x60cm  
60x120cm, 62x62cm

Certificates: CE/TÜV/SAA/RoHS

Colors: White

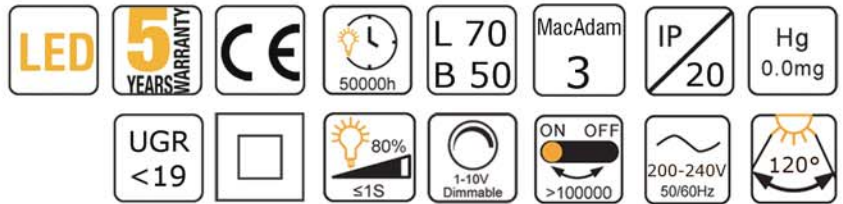
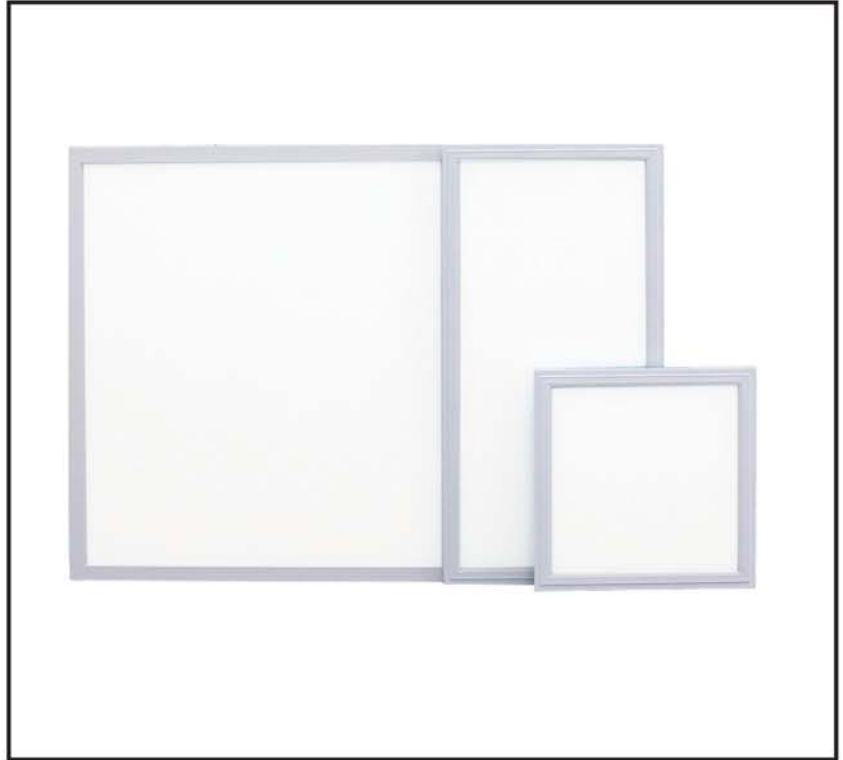

## PHOTOMETRIC CURVE

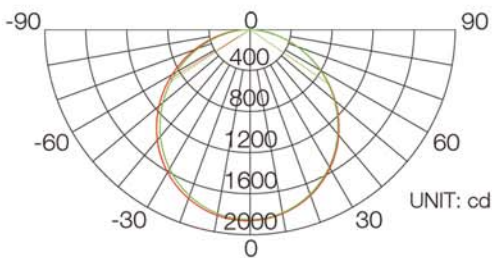

|           | A  | B   | C    |
|-----------|----|-----|------|
| 30600/1   | 10 | 295 | 295  |
| 30602/3   | 10 | 295 | 595  |
| 30604/5   | 10 | 295 | 1195 |
| 30606/7   | 10 | 595 | 595  |
| 30608/9   | 10 | 595 | 1195 |
| 306010/11 | 10 | 620 | 620  |

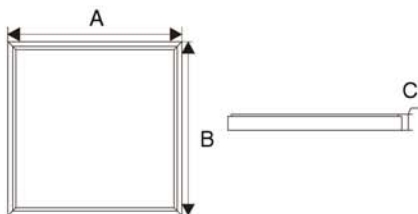

## AREA OF USE

Shops and other public places

## CAN BE DELIVERED WITH

3000K/4000K

| TYPE  | CRI    | LIGHT OUT | POWER | KELVIN |
|-------|--------|-----------|-------|--------|
| 30600 | >80 Ra | 2240 lm   | 16 W  | 3000K  |
| 30601 | >80 Ra | 2400 lm   | 16 W  | 4000K  |
| 30602 | >80 Ra | 2940 lm   | 21 W  | 3000K  |
| 30603 | >80 Ra | 3150 lm   | 21 W  | 4000K  |
| 30604 | >80 Ra | 3500 lm   | 25 W  | 3000K  |
| 30605 | >80 Ra | 3750 lm   | 25 W  | 4000K  |
| 30606 | >80 Ra | 3500 lm   | 25 W  | 3000K  |
| 30607 | >80 Ra | 3750 lm   | 25 W  | 4000K  |
| 30608 | >80 Ra | 7000 lm   | 50 W  | 3000K  |
| 30609 | >80 Ra | 7500 lm   | 50 W  | 4000K  |
| 30610 | >80 Ra | 3500 lm   | 25 W  | 3000K  |
| 30611 | >80 Ra | 3750 lm   | 25 W  | 4000K  |

# KØLD



Bœuf  
Richness  
30-

GRØN  
MARKED  
PR. 10-  
8stk. 100-

TOMME DE  
SAVOIE  
PR. 100 G. 19.99

KØD FISK & DELI

KØD FISK & DELI

KØD FISK & DELI

59-

28-

30-

99-

21-



## DESCRIPTION

Using Hi-quality, Hi-brightness LED as lighting source, high efficiency and energy-saving. Free from glare and flicker, and has average luminous surface. Aluminum heat-sink base and No Glare  
 110-120 Lm/W  
 LED Type: SMD4014

Installation:  
 Recessed / surface mounting / suspension installation

1-10V dimming or Non-dim-mable

Certificates: CE/RoHS

Colors: White



## AREA OF USE

Hotels, Offices, Commercial Purposes, Institution Buildings, Schools, Colleges, Universities, Hospitals

## CAN BE DELIVERED WITH

3000+4000K

|          | A   | B   | C |
|----------|-----|-----|---|
| SR panel | 595 | 595 | 9 |

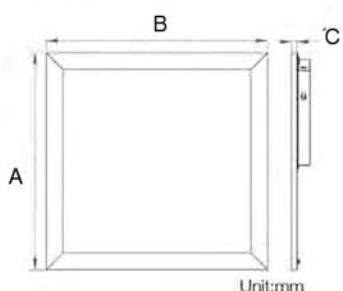

| TYPE  | CRI    | LIGHT OUT | POWER | COLOR TEMP | UGR |
|-------|--------|-----------|-------|------------|-----|
| 30430 | >80 Ra | 3960 lm   | 36 W  | 3000K      | >19 |
| 30431 | >80 Ra | 4140 lm   | 36 W  | 4000K      | >19 |
| 30432 | >80 Ra | 3960 lm   | 36 W  | 3000K      | <19 |
| 30433 | >80 Ra | 4140 lm   | 36 W  | 4000K      | <19 |



# Omega panel

## DESCRIPTION

Connect Bluetooth between the mobile phone and the smart panel light, then the mobile phone APP can control the lamp.

Users can adjust the brightness and color temperature of lamps according to their own needs.

Features and Advantages of Bluetooth Mesh Networking

The brightness can be adjusted automatically according to the ambient light intensity which collected by photosensor.

PIR sensor

The mobile phone APP can adjust the brightness, color temperature, on/off state of the photosensor and PIR sensor.

Material: Aluminium frame.

Surface mount/pendant/recessed

Certificates: CE/RoHS

Colors: White

## GATEWAY



Gateway with USB cable adaptor + user manual



## AREA OF USE

Hotels, Offices, Commercial Purposes, Institution Buildings, Schools, Colleges, Universities, Hospitals

## CAN BE DELIVERED WITH

3000-6500K  
Philips EasyAir sensor

|       | A   | B    | C   |
|-------|-----|------|-----|
| 30440 | 595 | 595  | 8.5 |
| 30340 | 295 | 1195 | 8.5 |

| TYPE  | CRI     | LIGHT OUT   | POWER | COLOR TEMP |
|-------|---------|-------------|-------|------------|
| 30440 | >80 Ra  | 3300-4000Lm | 40 W  | 3000-6500K |
| 30340 | >80 Ra  | 3300-4000Lm | 40 W  | 3000-6500K |
| 30940 | Gateway |             |       |            |



**Accessories for panel**

LED PANEL



**Suspension kits**



**Surface mounting kits  
30x30cm panel/  
60x60cm panel**



**Emergency kit  
Can be delivered on  
request**



**Surface mounting kits  
30x120cm panel/  
60x120cm panel**





**Verona Round Light Direct**

Lumen output  
Max. 20000 Lm

Page 87



**Calypso Pendant**

Lumen output  
Max. 5000Lm

Page 94



**Verona Round Light Up/Down**

Lumen output  
Max. 20000 Lm

Page 88



**Calypso Mini Pendant**

Lumen output  
Max. 1900Lm

Page 96



**Moon**

Lumen output  
Max. 12000 Lm

Page 89



**DSG Pendant**

Lumen output  
Max. 1520Lm

Page 97



**Palermo**

Lumen output  
Max. 14400 Lm

Page 91



**Halo Ring**

Lumen output  
Max. 4500 Lm

Page 92







## DESCRIPTION

The round Verona luminaire is optimised to meet the demands of contemporary offices, conference rooms of all kinds, as well as other applications. Covered with the cord pendant, rod pendant, ceiling, recessed and wall-mounted luminaires incorporate a homogeneous light surface. The elegant Verona fitting thereby complements interior architecture and simultaneously creates a pleasant working atmosphere. Verona generates extremely homogeneous, glare-free, powerful and yet soft light.

Certificates: CE/ETL/CCC

Beam angle 90° or 120°

Colors: White/black/silver



|         |                  |         |                 |              |           |       |          |
|---------|------------------|---------|-----------------|--------------|-----------|-------|----------|
| LED     | 5 YEARS WARRANTY | CE      | 50000h          | L 70<br>B 50 | MacAdam 3 | IP 20 | Hg 0.0mg |
| UGR <19 | ON OFF >100000   | 80% ≤1S | 90-277V 50/60Hz |              |           |       |          |

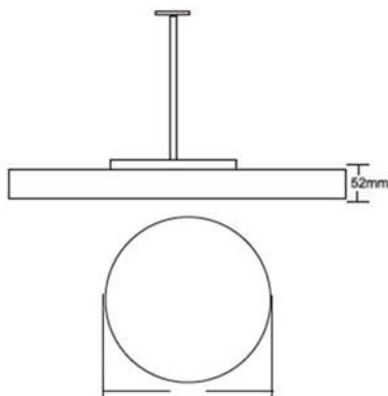
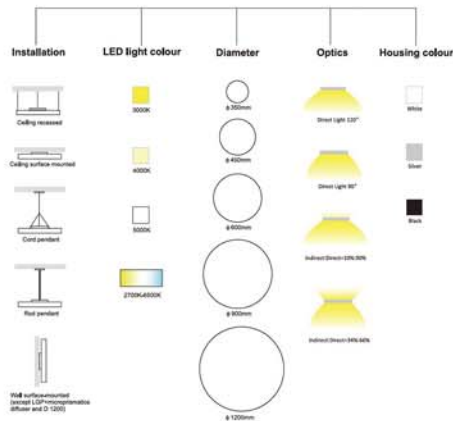

D350mm / D450mm / D600mm / D900mm / D1200mm

## AREA OF USE

Office, Education, Healthcare, Public

## CAN BE DELIVERED WITH:

2700K - 6500K

| TYPE  | CRI   | LIGHT OUT | POWER | COLOR TEMP |
|-------|-------|-----------|-------|------------|
| 40000 | 80 Ra | 2000 lm   | 15 W  | 2700-6500K |
| 40010 | 80 Ra | 2400 lm   | 18 W  | 2700-6500K |
| 40020 | 80 Ra | 4000 lm   | 23 W  | 2700-6500K |
| 40030 | 80 Ra | 5000 lm   | 31 W  | 2700-6500K |
| 40040 | 80 Ra | 6000 lm   | 46 W  | 2700-6500K |
| 40050 | 80 Ra | 8000 lm   | 62 W  | 2700-6500K |
| 40060 | 80 Ra | 12000 lm  | 92 W  | 2700-6500K |
| 40070 | 80 Ra | 16000 lm  | 123 W | 2700-6500K |
| 40080 | 80 Ra | 16000 lm  | 123 W | 2700-6500K |
| 40090 | 80 Ra | 20000 lm  | 152 W | 2700-6500K |

## DESCRIPTION

The round Verona luminaire is optimised to meet the demands of contemporary offices, conference rooms of all kinds, as well as other applications. Covered with the cord pendant, rod pendant, ceiling, recessed and wall-mounted luminaires incorporate a homogeneous light surface. The elegant Verona fitting thereby complements interior architecture and simultaneously creates a pleasant working atmosphere. Verona generates extremely homogeneous, glare-free, powerful and yet soft light.

Certificates: CE/ETL/CCC

Beam angle 90° or 120°

Colors: White/black/silver



|                   |                          |                |                        |                            |                  |              |                 |
|-------------------|--------------------------|----------------|------------------------|----------------------------|------------------|--------------|-----------------|
| <b>LED</b>        | <b>5 YEARS WARRANTY</b>  | <b>CE</b>      | 50000h                 | <b>L 70</b><br><b>B 50</b> | <b>MacAdam 3</b> | <b>IP 20</b> | <b>Hg 0.0mg</b> |
| <b>UGR &lt;19</b> | <b>ON OFF &gt;100000</b> | <b>80% ≤1S</b> | <b>90-277V 50/60Hz</b> |                            |                  |              |                 |

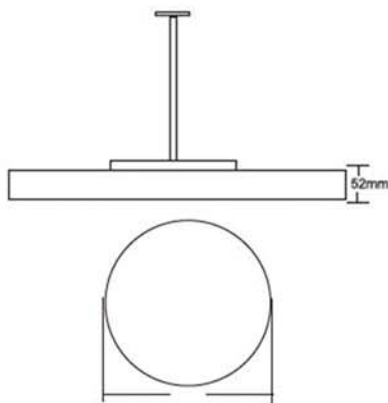
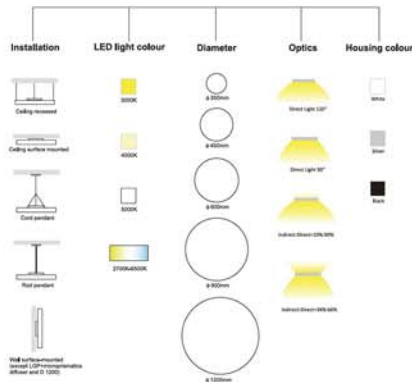

D350mm / D450mm / D600mm / D900mm / D1200mm

## AREA OF USE

Office, education, healthcare, public etc.

## CAN BE DELIVERED WITH:

2700K - 6500K

| TYPE  | CRI   | LIGHT OUT      | POWER | COLOR TEMP |
|-------|-------|----------------|-------|------------|
| 40100 | 80 Ra | 260+2400 lm    | 20 W  | 2700-6500K |
| 40110 | 80 Ra | 1200+2400 lm   | 27 W  | 2700-6500K |
| 40120 | 80 Ra | 445+4000 lm    | 34 W  | 2700-6500K |
| 40130 | 80 Ra | 2000+4000 lm   | 48 W  | 2700-6500K |
| 40140 | 80 Ra | 888+8000 lm    | 68 W  | 2700-6500K |
| 40150 | 80 Ra | 4000+8000 lm   | 91 W  | 2700-6500K |
| 40160 | 80 Ra | 1777+16000 lm  | 136 W | 2700-6500K |
| 40170 | 80 Ra | 8000+16000 lm  | 184 W | 2700-6500K |
| 40180 | 80 Ra | 2222+20000 lm  | 171 W | 2700-6500K |
| 40190 | 80 Ra | 10000+20000 lm | 231 W | 2700-6500K |



**DESCRIPTION**

This product adopts simple and clean concept. Low UGR help offer the most comfortable lighting environment, Up and down light could help make the lighting environment look more spacious. The products advantage: uniform luminescence, no spots. Standard delivery: Switch for Direct or Indirect Light + Switch for 3000 or 4000 K. Dali Driver and Microprisma- tisc diffuser UGR <19.

Installation: surfaced , wall , suspended cable and suspended rod. Luminous Efficacy: up to 120 Lm/W

Certificates: CE/RoHS  
Beam angle 110°

Colors: White/black



|     |                  |    |        |      |            |                    |          |
|-----|------------------|----|--------|------|------------|--------------------|----------|
| LED | 5 YEARS WARRANTY | CE | 50000h | L 90 | MacAdam >3 | IP 20              | Hg 0.0mg |
|     |                  |    |        |      | URG <19    | 100-277V/ 200-240V | 110°     |



**AREA OF USE**

Lobby, office, hotel other public places

**CAN BE DELIVERED WITH:**

2700K-6500K  
Non DIM/DIM 1-10V/ DIM TRAIC/ Casambi

|       | A     | B   | C     |
|-------|-------|-----|-------|
| 40700 | Ø435  | 115 | 80/90 |
| 40710 | Ø585  | 115 | 80/90 |
| 40720 | Ø735  | 115 | 80/90 |
| 40730 | Ø875  | 115 | 80/90 |
| 40740 | Ø1150 | 115 | 80/90 |

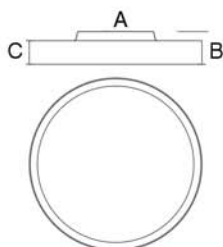

| TYPE  | CRI   | LIGHT OUT | POWER | COLOR TEMP |
|-------|---|-----------|-------|------------|
| 40700 | >80 Ra  | 4400 Lm   | 40 W  | 3000/4000K |
| 40710 | >80 Ra  | 6600 Lm   | 60 W  | 3000/4000K |
| 40720 | >80 Ra  | 7000 Lm   | 70 W  | 3000/4000K |
| 40730 | >80 Ra  | 9000 Lm   | 90 W  | 3000/4000K |
| 40740 | >80 Ra  | 12000 Lm  | 120 W | 3000/4000K |
| 40750 | Suspension Kit Wire 1500mm                          |           |       |            |
| 40760 | Suspension Kit Rod mounted 1500mm (450/600/750/900) |           |       |            |
| 40770 | Suspension Kit Rod mounted 1500mm (1200) 3 pcs.     |           |       |            |





## DESCRIPTION

LED Round luminaire Surfaced mounted/Pendant Microprismatic diffuser

Material: aluminium

Available in Different sizes

from Ø435mm up to

Ø1150mm

Dimmable/DALI

Beam Angle: 120°

Certificates: CE

Color: White/black/silver

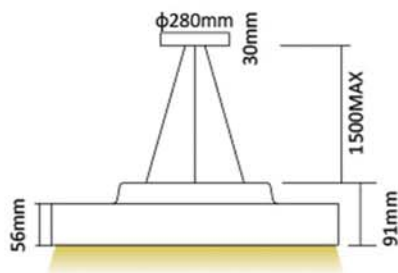
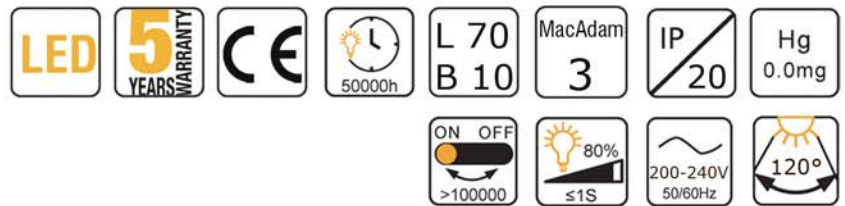

Direct light

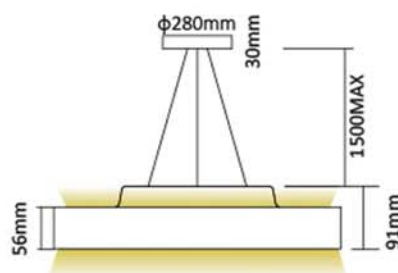

Direct and indirect lighting

## AREA OF USE

Hotel, meeting room, office, school, etc.

## CAN BE DELIVERED WITH:

2700K-6500K

| TYPE  | CRI    | LIGHT OUT | POWER | KELVIN | DIMENSION  |
|-------|--------|-----------|-------|--------|------------|
| 40500 | >80 Ra | 3600 lm   | 30 W  | 3000K  | Ø435*86mm  |
| 40510 | >80 Ra | 4800 lm   | 40 W  | 3000K  | Ø435*86mm  |
| 40520 | >80 Ra | 4800 lm   | 40 W  | 3000K  | Ø585*86mm  |
| 40530 | >80 Ra | 7200 lm   | 60 W  | 3000K  | Ø585*86mm  |
| 40540 | >80 Ra | 6000 lm   | 50 W  | 3000K  | Ø735*86mm  |
| 40550 | >80 Ra | 8400 lm   | 70 W  | 3000K  | Ø735*86mm  |
| 40560 | >80 Ra | 8400 lm   | 70 W  | 3000K  | Ø875*86mm  |
| 40570 | >80 Ra | 10800 lm  | 90 W  | 3000K  | Ø875*86mm  |
| 40580 | >80 Ra | 10800 lm  | 90 W  | 3000K  | Ø1150*86mm |
| 40590 | >80 Ra | 14400 lm  | 120 W | 3000K  | Ø1150*86mm |



# Halo Ring

LED PENDANT

## DESCRIPTION

This product adopts simple and clean concept.  
 Mounting: Suspending, Ceiling surface, Recessed mounting  
 No dark area, lighting uniformly, excellent heat dissipation performance

Luminous efficacy: 110Lm/W  
 Color Rendering Index: Ra>80 or Ra>90(upgrade)

ENEC, UL certified driver, flicker free, driver build-in, power factor >0.9

Material: 1.5mm thick extrusion aluminum profile housing, frosted PC cover

Diameter available in: 0.45m, 0.6m, 0.78m, 0.9m, 1.0m, 1.2m, 1.5m, 2.0m, 2.4m, 3.0m, 4.0m, 5.0m

Certificates: CE/RoHS

Colors: White or black. Silver or golden is optional to upgrade

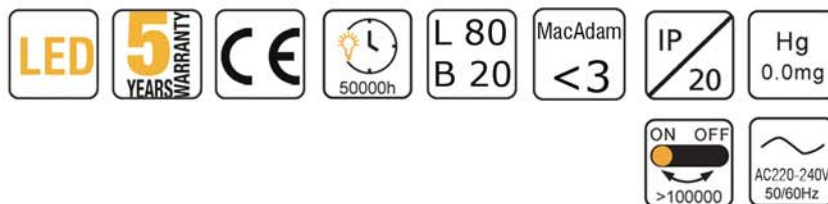

## AREA OF USE

Office, Mall, Station, Shops, Restaurant, Bank and other public places

## CAN BE DELIVERED WITH:

3000K/4000K/6000K  
 Dimming: DALI/Casambi/Master Connect

| TYPE  | CRI    | LIGHT OUT | POWER | DIMENSION |
|-------|--------|-----------|-------|-----------|
| 80100 | >80 Ra | 2000 lm   | 20 W  | Ø450mm    |
| 80101 | >80 Ra | 3000 lm   | 30 W  | Ø600mm    |
| 80102 | >80 Ra | 4000 lm   | 40 W  | Ø900mm    |
| 80103 | >80 Ra | 5000 lm   | 50 W  | Ø1000mm   |
| 80104 | >80 Ra | 6000 lm   | 60 W  | Ø1200mm   |
| 80105 | >80 Ra | 8000 lm   | 80 W  | Ø1560mm   |
| 80106 | >80 Ra | 11000 lm  | 110 W | Ø1860mm   |
| 80107 | >80 Ra | 12000 lm  | 120 W | Ø2060mm   |
| 80108 | >80 Ra | 15000 lm  | 150 W | Ø2460mm   |
| 80109 | >80 Ra | 18000 lm  | 180 W | Ø3060mm   |
| 80110 | >80 Ra | 24000 lm  | 240 W | Ø4060mm   |
| 80111 | >80 Ra | 32000 lm  | 320 W | Ø5060mm   |





## DESCRIPTION

Surface mounted ceiling light.

Housing made out of die cast aluminium.

Easy to install

High purity aluminium reflector consist of 99,9% aluminium. Philips SLM G7 slim system allow to produce fixture of homogenous lighting performance and high-efficiency natural looking light.

Certificates: CE/ETL/CCC

Beam angle 12°/24°/36°/50°

Colors: White/black/silver



LED PENDANT

|     |                  |    |        |              |                |         |                 |
|-----|------------------|----|--------|--------------|----------------|---------|-----------------|
| LED | 5 YEARS WARRANTY | CE | 50000h | L 70<br>B 50 | MacAdam 3      | IP 20   | Hg 0.0mg        |
|     |                  |    |        |              | ON OFF >100000 | 80% ≤1S | 90-277V 50/60Hz |

## PHOTOMETRIC CURVE

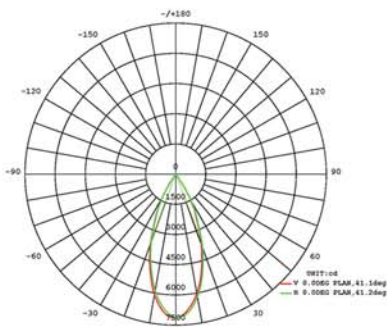

|       | A     | B      |
|-------|-------|--------|
| 40400 | 258mm | Ø125mm |

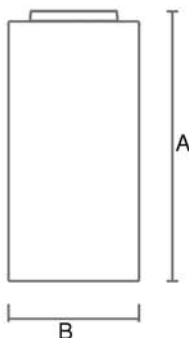

## AREA OF USE

Bedroom, living room, corridor, shops, office, hotel, restaurant

## CAN BE DELIVERED WITH:

- 4000K
- Food COB
- Meat COB

| TYPE  | CRI    | LIGHT OUT | POWER | COLOR TEMP |
|-------|--------|-----------|-------|------------|
| 40400 | >80 Ra | 3000 lm   | 21 W  | 3000K      |
| 40400 | >80 Ra | 3500 lm   | 25 W  | 3000K      |
| 40400 | >80 Ra | 4000 lm   | 27 W  | 3000K      |
| 40400 | >80 Ra | 4500 lm   | 31 W  | 3000K      |
| 40400 | >80 Ra | 5000 lm   | 35 W  | 3000K      |
| 40400 | >90 Ra | 3000 lm   | 26 W  | 3000K      |
| 40400 | >90 Ra | 3500 lm   | 32 W  | 3000K      |
| 40400 | >90 Ra | 4000 lm   | 33 W  | 3000K      |
| 40400 | >90 Ra | 4500 lm   | 38 W  | 3000K      |
| 40400 | >90 Ra | 5000 lm   | 43 W  | 3000K      |





# Calypso Mini Pendant

## DESCRIPTION

Suspended pendant  
Easy to install

Aluminium profile provides excellent thermal dissipation. Isolated driver solution both in dimmable and non-dimmable version achieves stable working performance.

Certificates: CE/SAA/RoHS

Colors: White/black



LED PENDANT

|                |                  |     |        |              |                   |            |                 |
|----------------|------------------|-----|--------|--------------|-------------------|------------|-----------------|
| LED            | 5 YEARS WARRANTY | CE  | 40000h | L 80<br>B 10 | MacAdam<br>3      | IP<br>20   | Hg<br>0.0mg     |
| 1-10V Dimmable | Grounding symbol | 15° | 24°    | 36°          | ON OFF<br>>100000 | 80%<br>≤1S | 240V<br>50/60Hz |

## PHOTOMETRIC CURVE

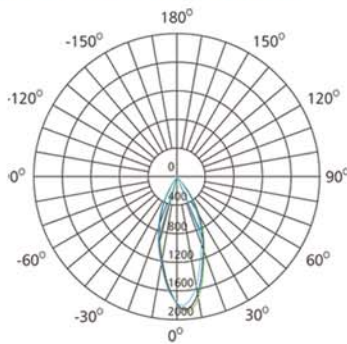

|          | A    | B   |
|----------|------|-----|
| 40300/10 | Ø80  | 130 |
| 40320/30 | Ø80  | 160 |
| 40340/50 | Ø113 | 160 |

## AREA OF USE

Bedroom, living room, corridor, shops, office, hotel, restaurant etc.

## CAN BE DELIVERED WITH

2700K/3000K/4000K/5000K

| TYPE  | CRI    | LIGHT OUT | POWER | COLOR TEMP |
|-------|--------|-----------|-------|------------|
| 40300 | >80 Ra | 850 lm    | 10 W  | 2700K      |
| 40310 | >80 Ra | 860 lm    | 10 W  | 3000K      |
| 40320 | >80 Ra | 1400 lm   | 18 W  | 2700K      |
| 40330 | >80 Ra | 1450 lm   | 18 W  | 3000K      |
| 40340 | >80 Ra | 1880 lm   | 25 W  | 2700K      |
| 40350 | >80 Ra | 1970 lm   | 25 W  | 3000K      |

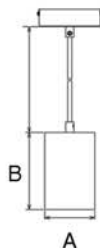

## DESCRIPTION

Industrial and simple design  
 Surface mounted ceiling lamp  
 Easy to install  
 Material body: metal  
 Glass plate  
 Ceiling plate: metal  
 Black cabel wire: 1,2m  
 Light source E27 max. 60W

Certificates: CE

Color: Black

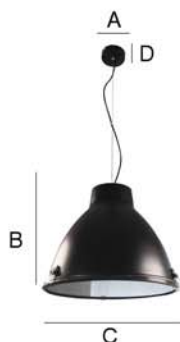
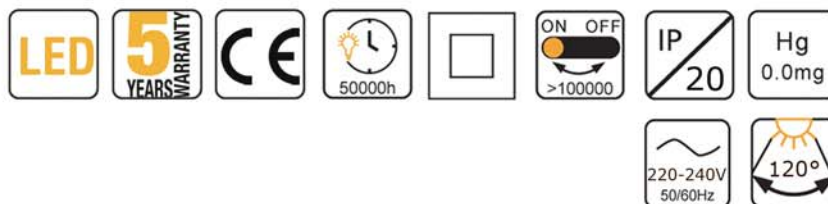

## AREA OF USE

Hotel, meeting room, office, school, living room, corridor, shops, restaurant etc.

|       | A  | B   | C   | D |
|-------|----|-----|-----|---|
| 40600 | 10 | 565 | 430 | 2 |

| TYPE  | CRI   | LIGHT OUT | POWER  | KELVIN |
|-------|-------|-----------|--------|--------|
| 40600 | 80 Ra | 1521 lm   | 13,5 W | 2700K  |



# Office Lights

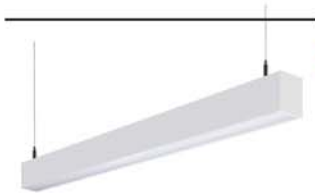

**Everline**  
Lumen output  
Max. 10.000 Lm

Page 99

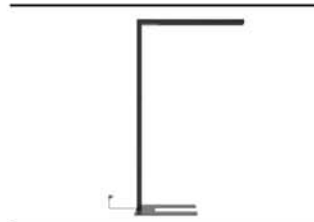

**Rho**  
Lumen output  
Max. 9000 Lm

Page 107



**Asti**  
Lumen output  
Max. 12.000 Lm

Page 101

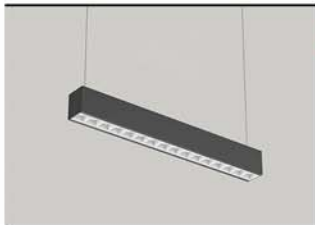

**Caivano**  
Lumen output  
Max. 4000 Lm

Page 102



**Capri**  
Lumen output  
Max. 12.000 Lm

Page 104



## DESCRIPTION

High light efficiency of more than 140lm/W  
 Optimal glare control, UGR<19  
 Seamless connection and no light leakage  
 Uniform illumination, direct and indirect light  
 Standalone type and continuous row optional  
 compact profile with refined surface finish  
 Can be flexibly connected to myriad of shapes  
 Comply with EN12464-1 standart  
 Easy installation without tool needed  
 No flickering, visual comfort  
 Can be delivered with motion sensor.

Continuous Luminaire

Certificates: CE/ETL/CCC

Colors: White/black/silver



|                     |                         |            |        |                            |                         |              |             |  |
|---------------------|-------------------------|------------|--------|----------------------------|-------------------------|--------------|-------------|--|
| <b>LED</b>          | <b>5 YEARS WARRANTY</b> | <b>CE</b>  | 50000h | <b>L 70</b><br><b>B 50</b> | MacAdam<br><b>&gt;3</b> | <b>IP 20</b> | Hg<br>0.0mg |  |
| 200-240V<br>50/60Hz | ON OFF<br>>100000       | 80%<br>≤1S |        |                            |                         |              |             |  |

## AREA OF USE

Office, education, healthcare, public

## CAN BE DELIVERED WITH:

3000K/4000K/5000K

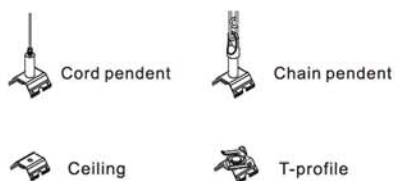

|          | A    | B  | C  |
|----------|------|----|----|
| 72100-20 | 1200 | 65 | 86 |
| 72130-50 | 1500 | 65 | 86 |
| 72160-80 | 3000 | 65 | 86 |

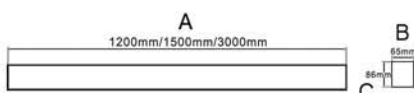

| TYPE  | CRI    | LIGHT OUT | POWER | COLOR TEMP |
|-------|--------|-----------|-------|------------|
| 72100 | >80 Ra | 2400 lm   | 17 W  | 3000K      |
| 72110 | >80 Ra | 3000 lm   | 22 W  | 3000K      |
| 72120 | >80 Ra | 4000 lm   | 29 W  | 3000K      |
| 72130 | >80 Ra | 3000 lm   | 22 W  | 3000K      |
| 72140 | >80 Ra | 4000 lm   | 29 W  | 3000K      |
| 72150 | >80 Ra | 5000 lm   | 36 W  | 3000K      |
| 72160 | >80 Ra | 6000 lm   | 43 W  | 3000K      |
| 72170 | >80 Ra | 8000 lm   | 57 W  | 3000K      |
| 72180 | >80 Ra | 10000 lm  | 72 W  | 3000K      |

Pendant

Ceiling-mounted

Recessed





## DESCRIPTION

Professional linear lights for Office and Public Area

Luminous efficacy: 140Lm/W

Mounting:  
Recessed/Pendant/Surface-mounted.

Individual or continuous configuration. Fast installation and easy maintenance.

Seamless connection without light leakage.  
Dot free illumination and screwless end cap.

Shining free and uniform light

Certificates: CE/ETL/CCC

Beam angle: 80°direct/  
140°indirect

Colors: White/black

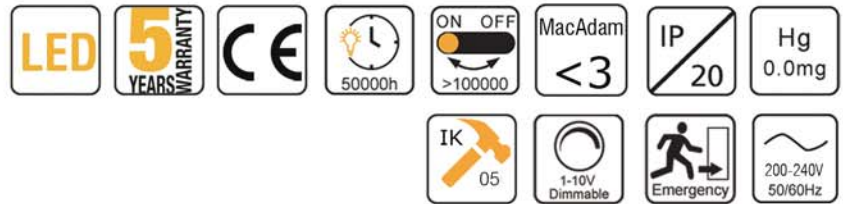
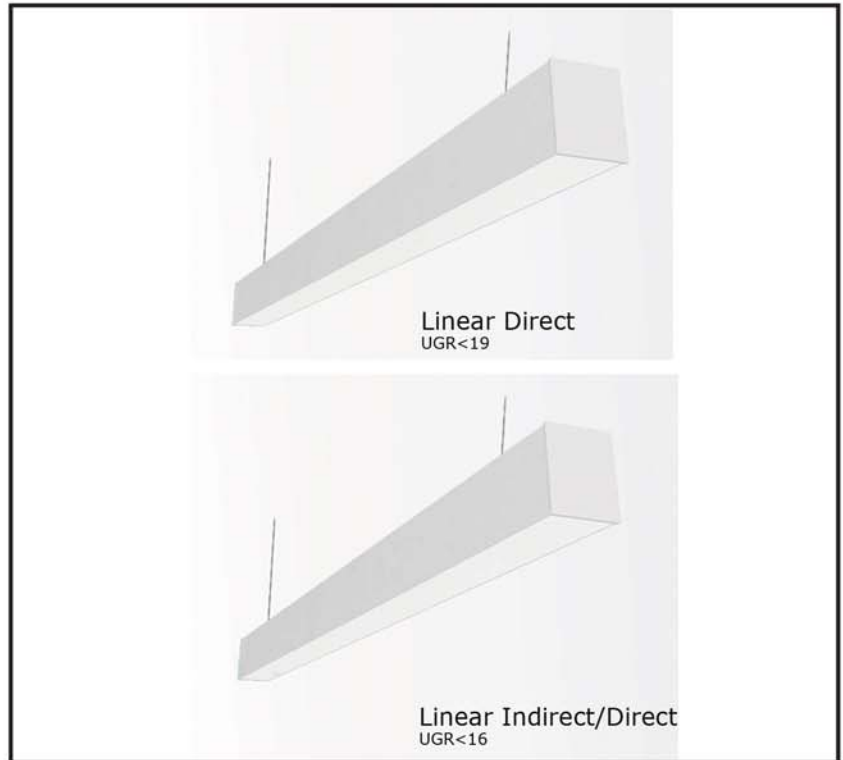

## PHOTOMETRIC CURVE

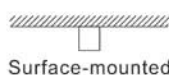
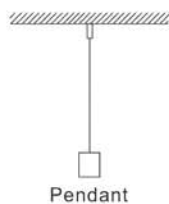
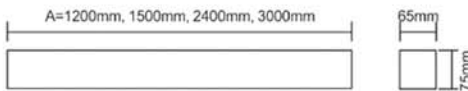
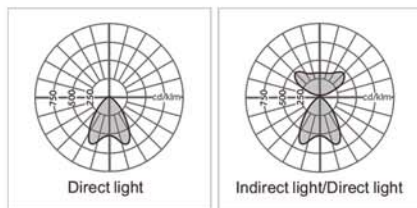

## AREA OF USE

Office, Education, Communication area and Public Area

## CAN BE DELIVERED WITH:

Optics: Direct or Indirect/Direct  
Control: On-Off/DALI/Push Dimming/CCT Turnable/  
Casambi/Human Centric Lighting/Sensor/Emergency  
CCT: 3000K/3500K/4000K/3000-6500K

| TYPE  | CRI    | LIGHT OUT | POWER | COLOR TEMP      |
|-------|--------|-----------|-------|-----------------|
| 50000 | >80 Ra | 3200 lm   | 25 W  | Direct          |
| 50010 | >80 Ra | 4000 lm   | 31 W  | Direct          |
| 50020 | >80 Ra | 6400 lm   | 50 W  | Direct          |
| 50030 | >80 Ra | 8000 lm   | 62 W  | Direct          |
| 50100 | >80 Ra | 4800 lm   | 37 W  | Indirect/Direct |
| 50110 | >80 Ra | 6000 lm   | 46 W  | Indirect/Direct |
| 50120 | >80 Ra | 9600 lm   | 74 W  | Indirect/Direct |
| 50130 | >80 Ra | 12000 lm  | 92 W  | Indirect/Direct |

## DESCRIPTION

DB45 is a module changeable design LED batten, provide good heat dissipation, quality light and substantial energy and maintenance savings. Suspended, surface mounted and splicing installation optional. The process of installing and maintaining is so easy.

Module changeable, with easy installation and maintenance  
Module type optional (type A reflector design, Type B diffuser design)

Color temperature switchable by DIP switch

Splicing design

Non-DIM

Certificates: CE

Beam angle 100°

Colors: White/black



|     |                  |    |        |              |           |                |                  |
|-----|------------------|----|--------|--------------|-----------|----------------|------------------|
| LED | 5 YEARS WARRANTY | CE | 50000h | L 80<br>B 50 | MacAdam 3 | IP 20          | Hg 0.0mg         |
|     |                  |    |        |              | UGR <19   | ON OFF >100000 | 200-240V 50/60Hz |

## AREA OF USE

For traditional suspended installation such as workshop, utility rooms, garages and more.

## CAN BE DELIVERED WITH:

3-CCT: 3000/4000/5700K

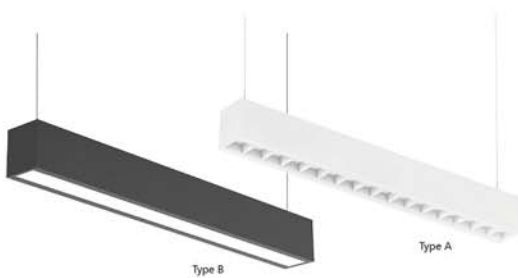

|          | A    | B  | C  |
|----------|------|----|----|
| 50420/30 | 1204 | 60 | 70 |

| TYPE  | CRI   | LIGHT OUT | POWER | COLOR TEMP |
|-------|-------|-----------|-------|------------|
| 50420 | 80 Ra | 4800 lm   | 40 W  | 3/4/5700K  |
| 50430 | 80 Ra | 4000 lm   | 40 W  | 3/4/5700K  |

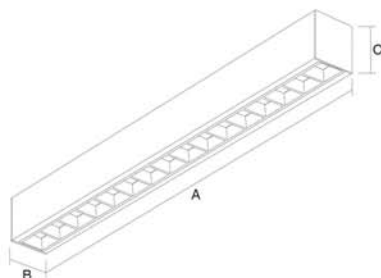







## DESCRIPTION

Professional linear lights for Office and Public Area

Luminous efficacy: 135 lm/W

Mounting:  
Recessed/Pendant/Surface-mounted.

Individual or continuous configuration. Fast installation and easy maintenance.

Seamless connection without light leakage.  
Dot free illumination and screwless end cap.

Shining free and uniform light

Certificates: CE/ETL/CCC

Beam angle: 70°direct/  
140°indirect

Colors: White/black

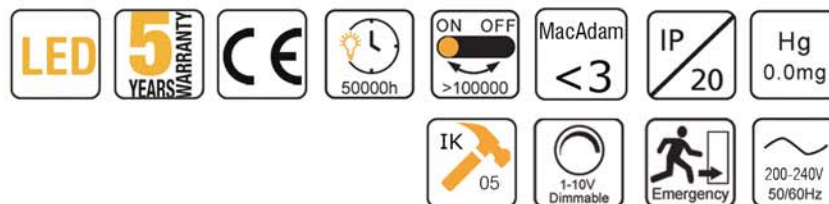

## PHOTOMETRIC CURVE

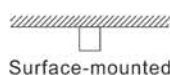
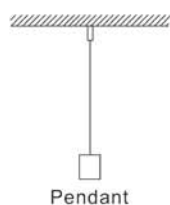
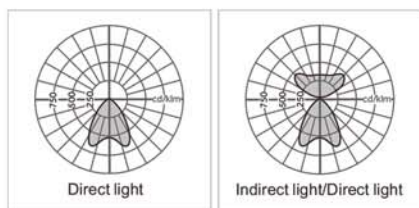

## AREA OF USE

Office, Education, Communication area and Public Area

## CAN BE DELIVERED WITH:

Optics: Direct or Indirect/Direct  
Control: On-Off/DALI/Push Dimming/CCT Turnable/  
Casambi/Human Centric Lighting/Sensor/Emergency  
CCT: 3000K/3500K/4000K/3000-6500K

| TYPE  | CRI    | LIGHT OUT | POWER | COLOR TEMP      |
|-------|--------|-----------|-------|-----------------|
| 50700 | >80 Ra | 3200 lm   | 25 W  | Direct          |
| 50701 | >80 Ra | 4000 lm   | 32 W  | Direct          |
| 50702 | >80 Ra | 6400 lm   | 50 W  | Direct          |
| 50703 | >80 Ra | 8000 lm   | 64 W  | Direct          |
| 50704 | >80 Ra | 4800 lm   | 38 W  | Indirect/Direct |
| 50705 | >80 Ra | 6000 lm   | 48 W  | Indirect/Direct |
| 50706 | >80 Ra | 9600 lm   | 76 W  | Indirect/Direct |
| 50707 | >80 Ra | 12000 lm  | 96 W  | Indirect/Direct |









## DESCRIPTION

Free standing, elegant and modular design.  
 Double side Lighting  
 UGR<13, glare-free and uniform light.  
 No flickering, visual comfort.

Motion Sensor

Housing made of die cast aluminium.  
 Lens Material: PMMA  
 Louver reflector Material: PC

Luminous efficacy: up-to 115 Lm/W

Easy installation and operation

Certificates: CE/ETL/CCC

Beam angle 12°/24°/36°/50°

Colors: Matt-White/matt-black

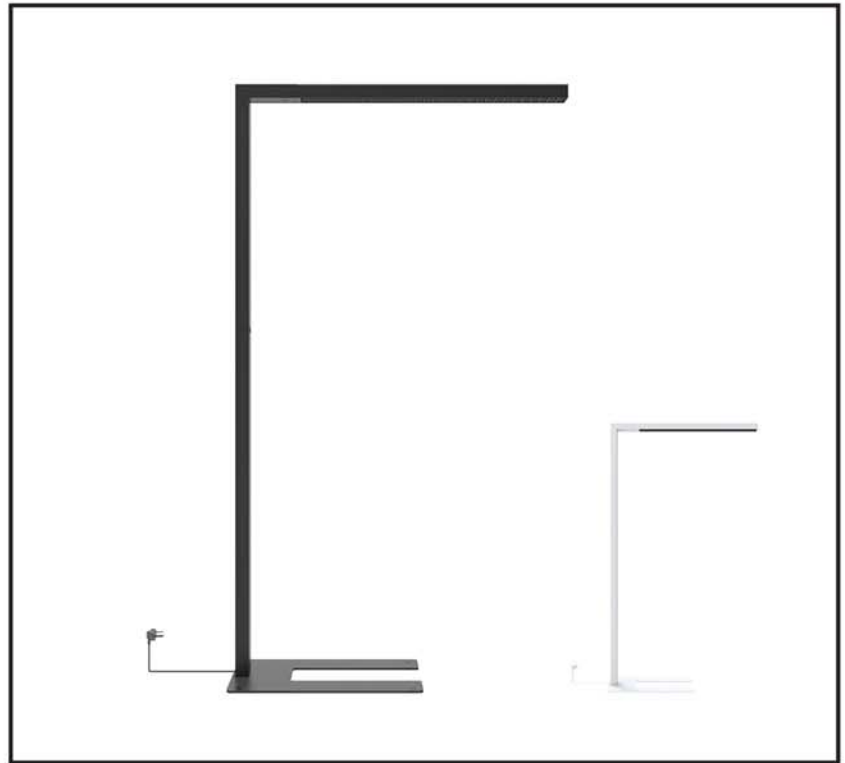

## PHOTOMETRIC CURVE

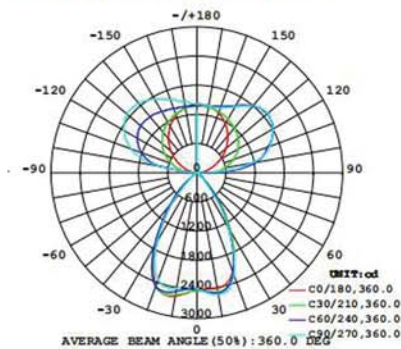

|          | A    | B    | C   | D   | E  |
|----------|------|------|-----|-----|----|
| 50500-01 | 2000 | 1118 | 360 | 635 | 64 |

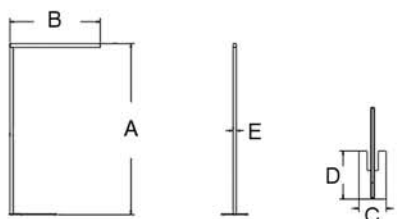

## AREA OF USE

School, University, Office Lighting and other public places

## CAN BE DELIVERED WITH

CCT: 3000K, 4000K, 3000K-6500K tunable  
 CRI: >80Ra, >90Ra

| TYPE  | CRI    | LIGHT OUT | POWER | COLOR TEMP |
|-------|--------|-----------|-------|------------|
| 50500 | >80 Ra | 7500 lm   | 65 W  | 3000K      |
| 50501 | >80 Ra | 9000 lm   | 81 W  | 3000K      |



## Magnet Module

Lumen output  
Max. 3100 Lm

Page 109



## Magnet Module Tri-color

Lumen output  
Max. 3200 Lm

Page 110



## Alpha Ceiling

Lumen output  
Max. 1900 Lm

Page 111



## Nova Fullmoon/ Halfmoon

Lumen output  
Max. 1000 Lm

Page 113



## Genova

Lumen output  
Max. 3290 Lm

Page 115



## Pluto Wall

Lumen output  
Max. 1000 Lm

Page 117



## Galbiate

Lumen output  
Max. 3290 Lm

Page 118

## DESCRIPTION

No UV or RF interference.  
 Ultra thin PCB panel design - only 1,3 mm.  
 Original Epistar chip.  
 Industrail powerful magnet, firm installation  
 23V direct installation  
 Available in: 3000/4000K

Certificates: LVD/EMC/RoHS

Colors: White

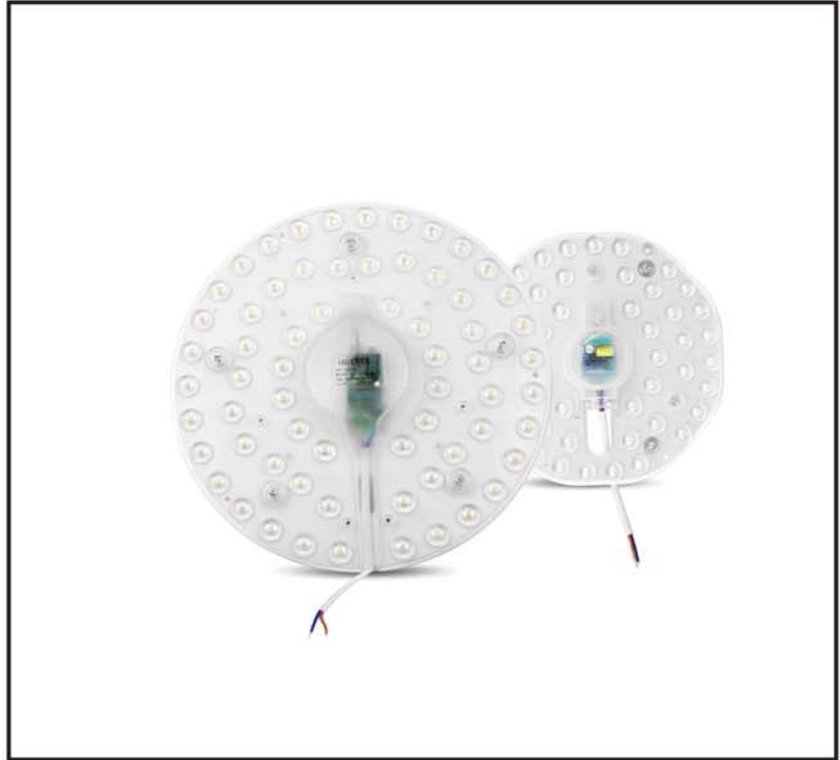

1.



**Notice: Switch off the power before installation.**

1. Open up the existing ceiling lamp, remove all the parts except for ceiling lamp panel and L, N wire

2.



3. Fix the PCB board into the middle of the lamp panel with magnet, install the outer cover.

3.



2. Connect new PCB board

4.



4. Switch on to work.

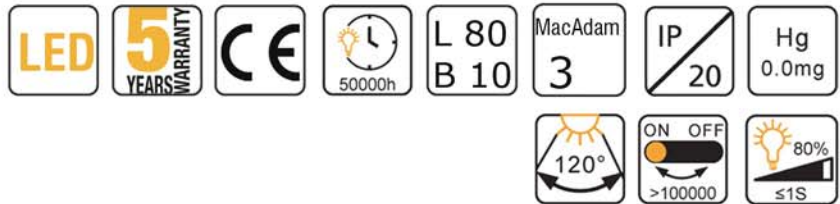

## AREA OF USE

Kitchen, hall, toilet, bathroom, corridor, passageway, living room, bedroom etc.

| A           |        |
|-------------|--------|
| 60000/1/2/3 | Ø110mm |
| 60004/5/6/7 | Ø180mm |
| 60008/9     | Ø180mm |

| TYPE  | CRI    | LIGHT OUT | POWER | COLOR TEMP |
|-------|--------|-----------|-------|------------|
| 60000 | >80 Ra | 1100 lm   | 12 W  | 3000K      |
| 60001 | >80 Ra | 1100 lm   | 12 W  | 3000K DIM  |
| 60002 | >80 Ra | 1100 lm   | 12 W  | 4000K      |
| 60003 | >80 Ra | 1100 lm   | 12 W  | 4000K DIM  |
| 60004 | >80 Ra | 2300 lm   | 24 W  | 3000K      |
| 60005 | >80 Ra | 2300 lm   | 24 W  | 3000K DIM  |
| 60006 | >80 Ra | 2300 lm   | 24 W  | 4000K      |
| 60007 | >80 Ra | 2300 lm   | 24 W  | 4000K DIM  |
| 60008 | >80 Ra | 3100 lm   | 32 W  | 3000K      |
| 60009 | >80 Ra | 3100 lm   | 32 W  | 4000K      |



## DESCRIPTION

No UV or RF interference.  
 Ultra thin PCB panel design.  
 Three sections of the switch:  
 pure white, warm white and  
 commercial white.  
 LED ceiling Module Light  
 LED type: SMD2835  
 Industrail powerful magnet,  
 firm installation

Certificates: CE/RoHS

Colors: White

1.



**Notice: Switch off the power before installation.**

1. Open up the existing ceiling lamp, remove all the parts except for ceiling lamp panel and L, N wire

2.



3. Fix the PCB board into the middle of the lamp panel with maonet. install the outer cover.

3.



2. Connect new PCB board

4.



4. Switch on to work.

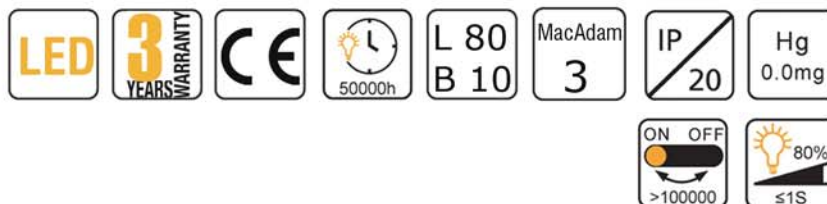

## AREA OF USE

Kitchen, hall, toilet, bathroom, corridor, passageway, living room, bedroom etc.

## CAN BE DELIVERED WITH:

3CCT/3000K/4500K/6000K

|       | A      |
|-------|--------|
| 60010 | Ø120mm |
| 60011 | Ø180mm |
| 60012 | Ø240mm |

| TYPE  | CRI    | LIGHT OUT | POWER | COLOR TEMP |
|-------|--------|-----------|-------|------------|
| 60010 | >80 Ra | 1200 lm   | 12 W  | 3/4/6000K  |
| 60011 | >80 Ra | 2400 lm   | 24 W  | 3/4/6000K  |
| 60012 | >80 Ra | 3200 lm   | 32 W  | 3/4/6000K  |

# Alpha Ceiling

## DESCRIPTION

Alpha is a new design ceiling light.

Wall mounted and surface mounted available.

The base and shade are detachable which make easier maintenance and installation.

High lumen efficiency  
100lm/W.  
Interchangeable CCT with slide switch.

Interchangeable wattage for round shape only.

Triac/ DALI/ 0-10V Dimmable.

Multiple functions : adjustable sensor, Emergency, adjustable power.

Materials of housing: PC

Certificates: CE/RoHS

Colors: White/black

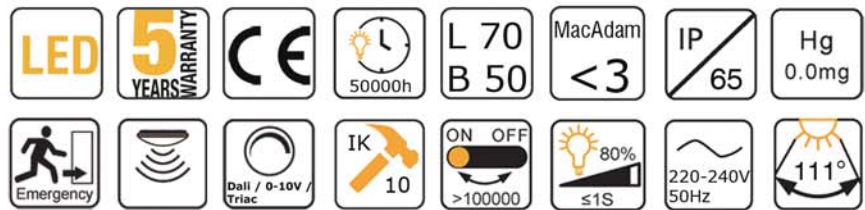

## AREA OF USE

Office, supermarket, shop, school, hotel, stairway, lobby etc.

## CAN BE DELIVERED WITH:

1-CCT: 3000K/4000K/5000K/5700K  
3-CCT: 3000K/4000K/5700K

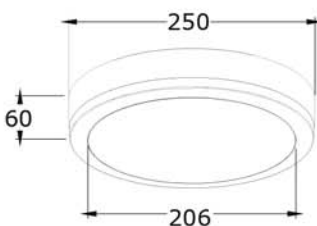

| TYPE  | CRI    | LIGHT OUT   | POWER | KELVIN | SENSOR |
|-------|--------|-------------|-------|--------|--------|
| 60400 | >80 Ra | 1100-1300Lm | 12 W  | 3-CCT  | No     |
| 60401 | >80 Ra | 1050-1250Lm | 12 W  | 3-CCT  | Adjust |
| 60403 | >80 Ra | 1600-1900Lm | 18 W  | 3-CCT  | Adjust |
| 60405 | >80 Ra | 1600-1900Lm | 18 W  | 3000K  | 1-10V  |





## DESCRIPTION

NOVA surface mounted ceiling light adopts high lumen SMD LED.

With IP65 waterproof design, it is an ideal replacement for any locations.

Dimmable versions available.

Normal light control with HF sensors and RF wireless grouping with master and slave are available.

Materials: Alu diecast and PC

Certificates: CE/RoHS

Beam angle 111°

Colors: Light grey



## PHOTOMETRIC CURVE

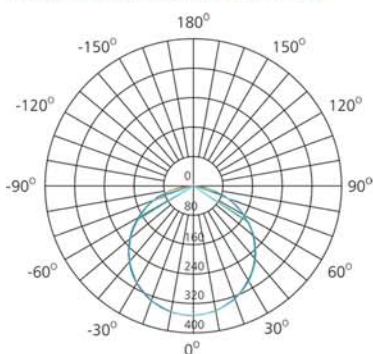

## AREA OF USE

Office, supermarket, shop, school, hotel, stairway, lobby, reception, corridors etc

## CAN BE DELIVERED WITH:

4000K  
6500K

Microwave sensor, RF sensor master/slave, emergency light, or dimmable versions available.

### Nova

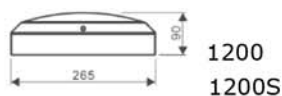

1200

1200S



1200(S)

1200(R)

### Nova-C

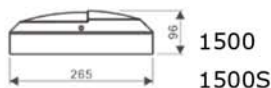

1500

1500S

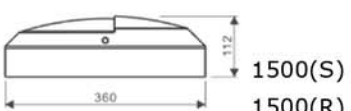

1500(S)

1500(R)

| TYPE  | CRI    | LIGHT OUT | POWER | KELVIN | SENSOR      |
|-------|--------|-----------|-------|--------|-------------|
| 60200 | >80 Ra | 750 lm    | 13 W  | 3000K  | No          |
| 60210 | >80 Ra | 750 lm    | 13 W  | 3000K  | Microwave   |
| 60220 | >80 Ra | 750 lm    | 13 W  | 3000K  | RF Sender   |
| 60230 | >80 Ra | 750 lm    | 13 W  | 3000K  | RF Receiver |
| 60240 | >80 Ra | 1000 lm   | 17 W  | 3000K  | No          |
| 60250 | >80 Ra | 1000 lm   | 17 W  | 3000K  | Microwave   |
| 60260 | >80 Ra | 1000 lm   | 17 W  | 3000K  | RF Sender   |
| 60270 | >80 Ra | 1000 lm   | 17 W  | 3000K  | RF Receiver |





## DESCRIPTION

DL38 surface mounted ceiling light.  
 Up to 70% energy saving compared to standard CFL  
 Dimmable when using triac dimmer  
 No UV/IR light  
 Easy to install  
 The lamp adopts high quality reflector which has good reflective rate and light output > 86%

Certificates: CE/SAA/RoHS

Colors: White/black



|                |                  |                |         |              |           |       |          |
|----------------|------------------|----------------|---------|--------------|-----------|-------|----------|
| LED            | 5 YEARS WARRANTY | CE             | 40000h  | L 80<br>B 10 | MacAdam 3 | IP 54 | Hg 0.0mg |
| 1-10V Dimmable |                  | ON OFF >100000 | 80% ≤1S | 24°          | 36°       | 60°   |          |

## PHOTOMETRIC CURVE

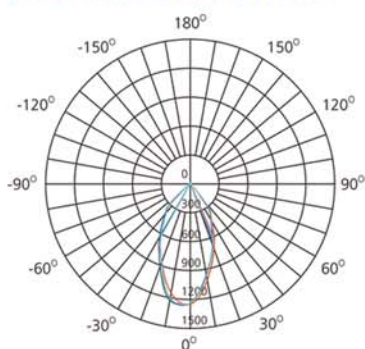

| A                  | B        |
|--------------------|----------|
| 60500/10/40/50/100 | Ø90      |
| 60520/60           | 110 Ø120 |
| 60530/70           | 120 Ø160 |

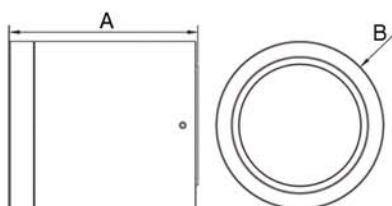

## AREA OF USE

Office, supermarket, shop, school, hotel, restaurant

## CAN BE DELIVERED WITH

4000K  
 5000K  
 5700K

| TYPE  | CRI    | LIGHT OUT | POWER | COLOR TEMP |
|-------|--------|-----------|-------|------------|
| 60500 | >80 Ra | 800 lm    | 10 W  | 3000K      |
| 60510 | >80 Ra | 1200 lm   | 15 W  | 3000K      |
| 60520 | >80 Ra | 2320 lm   | 25 W  | 3000K      |
| 60530 | >80 Ra | 3320 lm   | 35 W  | 3000K      |
| 60540 | >80 Ra | 760 lm    | 10 W  | 3000K      |
| 60550 | >80 Ra | 1160 lm   | 15 W  | 3000K      |
| 60560 | >80 Ra | 2270 lm   | 25 W  | 3000K      |
| 60570 | >80 Ra | 3290 lm   | 35 W  | 3000K      |





# Pluto Wall

## DESCRIPTION

Pluto Wall is an ultra-thin design which looks like a power bank. It adopted SMD light source in both ends with PC lens, wall-washing design for optic effect, so it can do higher and further lighting.

Ultra-thin with only 30.5mm thickness.  
Up & down lighting design.

Interchangeable CCT with slide switch.  
Internal flicker free driver.

Materials: ADC12 Aluminium

Beam angle: Polarized lens 8°

Colors: White/black



LED CEILING / WALL LIGHT

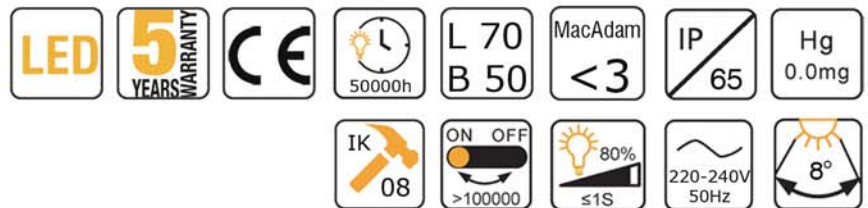

## PHOTOMETRIC CURVE

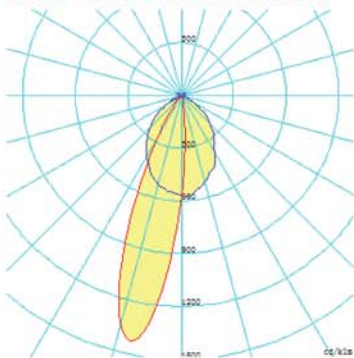

| TYPE | A   | B  | C    | D    | E     |
|------|-----|----|------|------|-------|
| 6W   | 135 | 90 | 30.5 | 36   | 66.1  |
| 10W  | 175 | 90 | 30.5 | 34.5 | 101.5 |

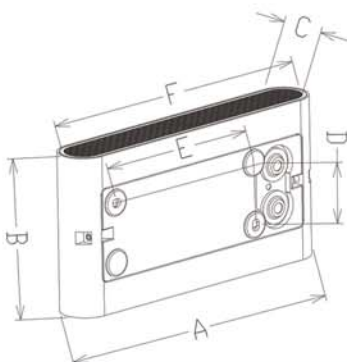

## AREA OF USE

Indoor and outdoor lighting applications hotel, park, corridors, school, stairway etc.

## CAN BE DELIVERED WITH:

Interchangeable CCT (3000k/4000K/5700K) with slide switch

| TYPE  | CRI    | LIGHT OUT   | POWER | KELVIN | Color |
|-------|--------|-------------|-------|--------|-------|
| 60410 | >80 Ra | 540-680 lm  | 6 W   | 3000K  | White |
| 60411 | >80 Ra | 540-680 lm  | 6 W   | 3000K  | Black |
| 60420 | >80 Ra | 950-1060 lm | 10 W  | 3000K  | White |
| 60421 | >80 Ra | 950-1060 lm | 10 W  | 3000K  | Black |

## DESCRIPTION

When funktion meet design  
 Die-casted lamp does not have to be only used outdoors.  
 Funktional wall light with unique modern design, applicable in any place.  
 Make the maintenance as easier as possible  
 Can be with half moon and full moon  
 Can be both wall mounting and surface mounting  
 Dual CCT is optional  
 3-Different brightness selectable  
 Durable performance, 5-yers warranty.  
 Aluminum case as heatsink

Certificates: CE/ETL/CCC

Colors: Black

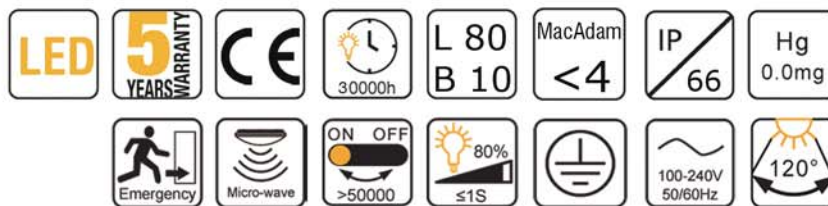

## AREA OF USE

Replaces fluorescent 2D lamp.  
 Bathroom, kitchen, stairwells and corridors

|                | A   | B  |
|----------------|-----|----|
| 60300/10/20/30 | 270 | 74 |
| 60340/50/60/70 | 340 | 83 |

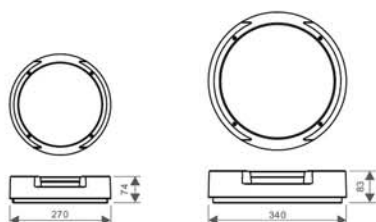

| TYPE  | CRI    | LIGHT OUT | POWER  | KELVIN | SENSOR |
|-------|--------|-----------|--------|--------|--------|
| 60300 | >80 Ra | 800 lm    | 9 W    | 4000K  | No     |
| 60310 | >80 Ra | 800 lm    | 10,5 W | 4000K  | Yes    |
| 60320 | >80 Ra | 1300 lm   | 15 W   | 4000K  | No     |
| 60330 | >80 Ra | 1300 lm   | 16,5 W | 4000K  | Yes    |
| 60340 | >80 Ra | 1300 lm   | 16 W   | 4000K  | No     |
| 60350 | >80 Ra | 1300 lm   | 16,5 W | 4000K  | No     |
| 60360 | >80 Ra | 1300 lm   | 17,5 W | 4000K  | Yes    |
| 60370 | >80 Ra | 1300 lm   | 18 W   | 4000K  | Yes    |





### Tri-proof Light

Lumen output  
Max. 8.400 Lm

Page 121



### Tri-proof SP

Lumen output

Page 123



### Taurus

Lumen output  
Max. 8.400 Lm

Page 125



### Tri-proof Round

Lumen output  
Max. 8.160 Lm

Page 126



### Damp Proof Housing

Lumen output  
Max. Lm

Page 128



### Sjoc Sport

Lumen output  
Max. 22.500 Lm

Page 129



### UFO Highway

Lumen output  
Max. 42.000 Lm

Page 130



### UFO Galaxy

Lumen output  
Max. 96.000 Lm

Page 131



### Flood Light

Lumen output  
Max. 74.400 Lm

Page 132



### HiSpot Flood Light

Lumen output  
Max. 11.250 Lm

Page 133



### HiMast Flood Light

Lumen output  
Max. 117.000 Lm

Page 134



### HiSmooth Street Light

Lumen output  
Max. 18.750 Lm

Page 135



### HiSmooth Street Light

Lumen output  
Max. 3.750 Lm

Page 137





### Sjoc Pullert R

Lumen output  
Max. 1.600Lm

Page 139



### Jupiter

Lumen output  
Max. 2.300 Lm

Page 145



### Sjoc One Pullert

Lumen output  
Max. 840 Lm

Page 141



### Floodlight Facade

Lumen output  
Max. 2.000 Lm

Page 146



### Sjoc Park One

Lumen output  
Max. 2.436 Lm

Page 143



### Sjoc Pullert F

Lumen output  
Max. 840 Lm

Page 144

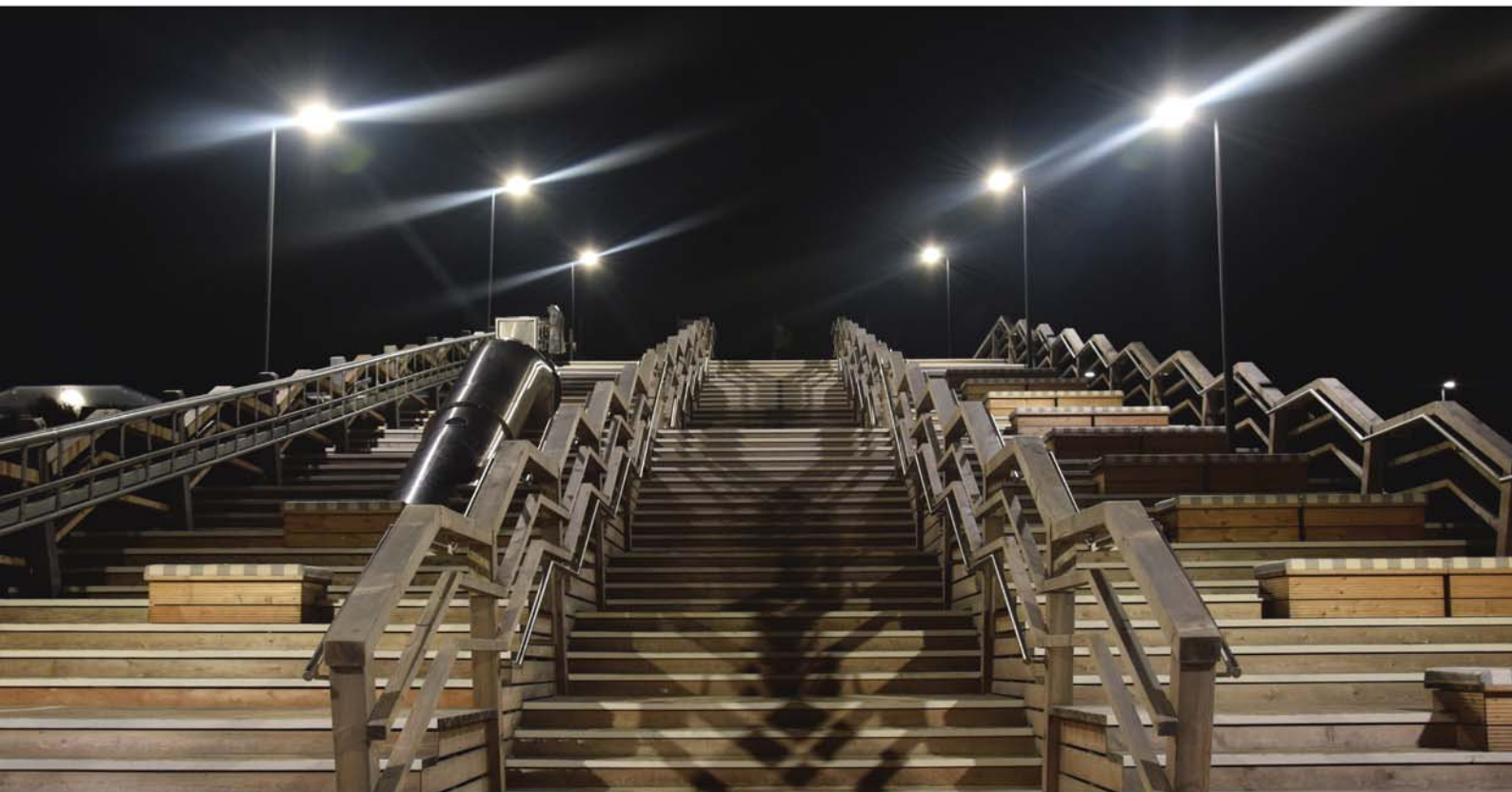

# Tri-proof light

LED INDUSTRIAL LIGHTING  
OUTDOOR LIGHTING

## DESCRIPTION

Power /CCT Turnable  
 Easy to open without tools  
 Tridonic Driver without flicker  
 Luminous efficacy 140Lm/W  
 Can be linkable  
 Fast fit and zero maintenance  
 Emergency / Microwave available  
 Detection zone: Max.(D x H):  
 12m x 6m  
 Max. Mounting height : 6m  
 Hold time: 5s/30s/90s/3min/20-  
 min/30min  
 Motion detection: 0.5~3m/s  
 Detection sensitivity: 10% / 25%  
 / 50% / 75% / 100%  
 Daylight sensor: 2lux / 10lux /  
 25lux / 50lux / Disable  
 Single or double wiring  
 Material: Aluminium board, PC  
 cover

Certificates: CE/RoHS

Colors: White

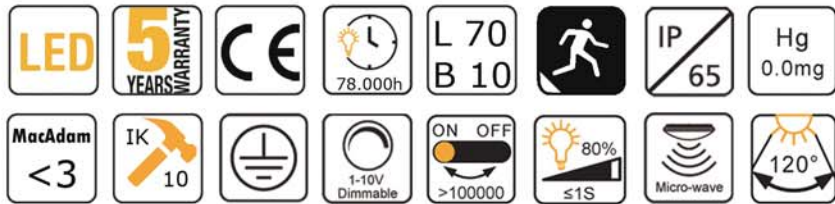

## AREA OF USE

Replaces fluorescent NCF fittings.  
 Warehouse and factories, car parks, sports facilities and food storage. Outdoor & indoor locations

## CAN BE DELIVERED WITH:

CCT setting: 3000K/4000K/5000K

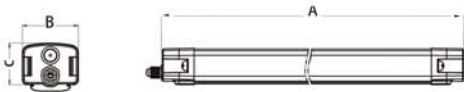

|          | A    | B  | C  |
|----------|------|----|----|
| 70000    | 600  | 84 | 63 |
| 70005/25 | 1200 | 84 | 63 |
| 70010/30 | 1500 | 84 | 63 |
| 70040    | 2400 | 84 | 63 |

| TYPE  | CRI    | LIGHT OUT | POWER        | KELVIN    |
|-------|--------|-----------|--------------|-----------|
| 70000 | >80 Ra | 140 Lm/W  | 22 W         | 3/4/5000K |
| 70005 | >80 Ra | 140 Lm/W  | 38/44/48/52W | 3/4/5000K |
| 70010 | >80 Ra | 140 Lm/W  | 40/50/55/60W | 3/4/5000K |
| 70025 | >80 Ra | 140 Lm/W  | 40 W         | 3/4/5000K |
| 70030 | >80 Ra | 140 Lm/W  | 40 W         | 3/4/5000K |
| 70040 | >80 Ra | 140 Lm/W  | 100 W        | 3/4/5000K |







**DESCRIPTION**

Power adjustable & CCT adjustable via DIP switch.  
Luminous efficacy 150Lm/W  
Max. Mounting height: 15m

Plug & Play Battery for Emergency: Easy for maintenance.  
Emergency driver: Self-testing ,long lifespan.  
PC diffuser: Won't yellowing after time goes by.  
Sensor ready: Plug-play ,flexible solution.

Can be linkable.  
Much bigger space for wiring.  
Loop in-out wiring: 3pcsX 2.5mm2 cables+ 2pcsX 1.5mm2 cables go through  
Built in sensor: Motion sensor + Daylight sensor

Certificates: CE/RoHS

Colors: White

Sensor base reserved in lamp



Sensor plug-play



|       | A    | B   | C  |
|-------|------|-----|----|
| 70060 | 1200 | 102 | 54 |
| 70065 | 1500 | 102 | 54 |
| 70070 | 1200 | 102 | 54 |



**AREA OF USE**

Warehouse and factories, car parks, sports facilities and food storage. Outdoor & indoor locations

**CAN BE DELIVERED WITH:**

- 25-65W Power adjustable
- 4000-5000-6500K CCT adjustable
- Type 1: PIR sensor + Daylight threshold
- Type 2: Microwave + daylight threshold
- Type 3: Microwave + daylight Harvesting
- Type 4: Microwave + Bluetooth control

| TYPE  | DIMMING                               | LIGHT OUT | POWER        | COLOR TEMP |
|-------|---------------------------------------|-----------|--------------|------------|
| 70060 | Non-dim                               | 150Lm/W   | 25-35-40-50W | Switchable |
| 70065 | Non-dim                               | 150Lm/W   | 25-35-40-50W | Switchable |
| 70070 | DALI                                  | 150Lm/W   | 60 W         | 4000K      |
| 70365 | Microwave + daylight threshold Sensor |           |              |            |
| 70367 | Remote Control                        |           |              |            |
| 70380 | Sensor base                           |           |              |            |
| 70381 | Hanging Clip suspension               |           |              |            |
| 70382 | Hanging Clip for suspension           |           |              |            |





## DESCRIPTION

Easy to open without tools  
 Driver: Philips/Lifud  
 Light source: Bridgelux LED  
 Power factor: >0.9  
 Luminous efficacy 140lm/W  
 Can be linkable  
 Fast fit and zero maintenance  
 Max. Mounting height: 6m  
 Material: Aluminium board, PC cover

Certificates: CE

Colors: White

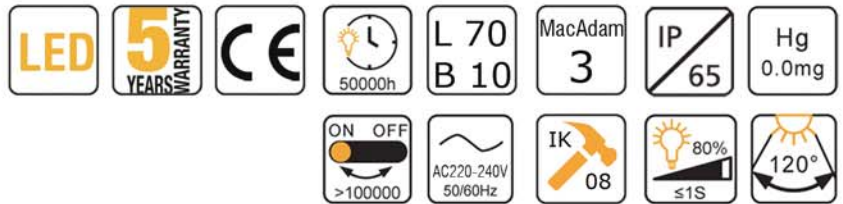
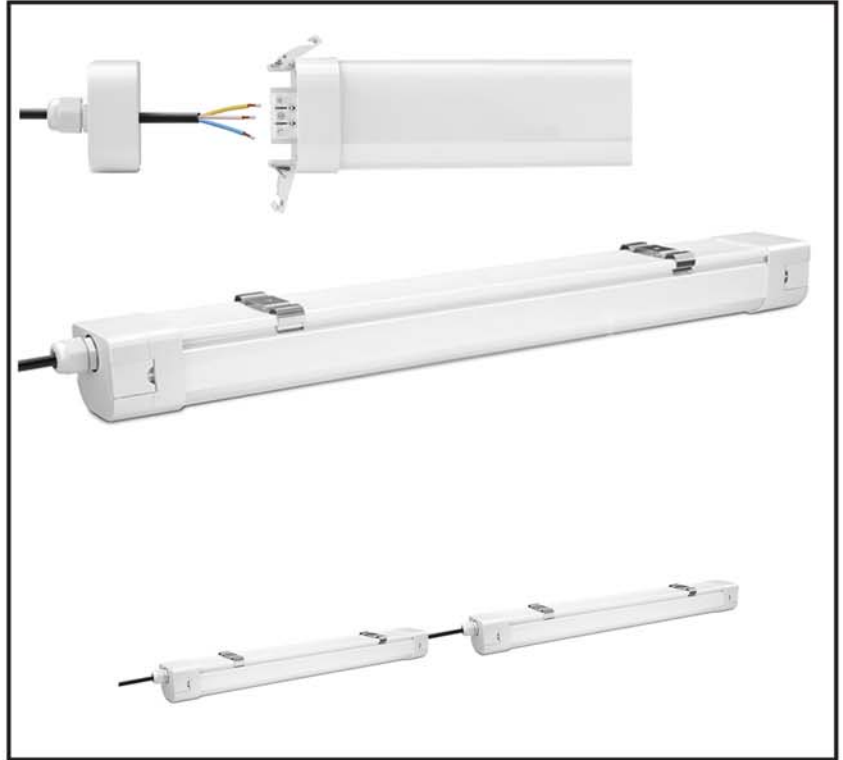

## AREA OF USE

Replaces fluorescent NCF fittings.  
 Warehouse and factories, car parks, sports facilities and food storage. Outdoor & indoor locations

|          | A    | B  | C  |
|----------|------|----|----|
| 70080-81 | 1221 | 74 | 64 |
| 70082-83 | 1502 | 74 | 64 |

| TYPE  | CRI    | LIGHT OUT | POWER | KELVIN     |
|-------|--------|-----------|-------|------------|
| 70080 | >80 Ra | 4200 lm   | 30 W  | 4000/5000K |
| 70081 | >80 Ra | 5600 lm   | 40 W  | 4000/5000K |
| 70082 | >80 Ra | 6300 lm   | 45 W  | 4000/5000K |
| 70083 | >80 Ra | 8400 lm   | 60 W  | 4000/5000K |

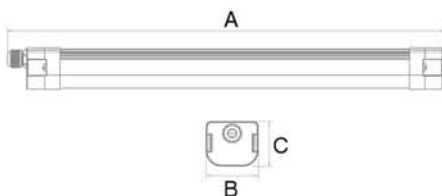

### DESCRIPTION

Tri-proof Round is ingress protected and air-tight, which makes it suitable for versatile application.

Light efficacy: 170 lm/W (140 lm/W at +25°C)

Heat management: Passive heat sink in aluminium

Housing: Polymethyl methacrylate

End caps, bracket: 316 stainless steel

IP69K can stand 1450psi high pressure wash-down.

High temperature resistant black rubber wire.

Dimmable function available.

Wall, ceiling and suspending mounting

Certificates:

CE/RoHS/ENEC/DLG

Beam angle 120°

Colors: White

### PHOTOMETRIC CURVE

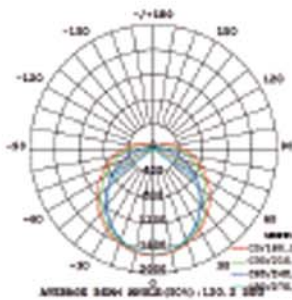

|             | A    | B  | C  |
|-------------|------|----|----|
| 70090+70092 | 1200 | 70 | 70 |
| 70091+70093 | 1500 | 70 | 70 |

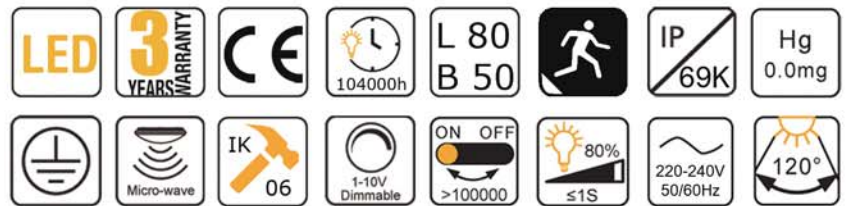
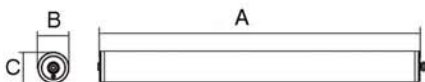

### AREA OF USE

Food industry, Agriculture(Farm, Cold storage ... ), Swimming pool, Tire production, Train station/subway /airport etc.

### CAN BE DELIVERED WITH:

DALI, 0/1-10V, Microwave sensor options

| TYPE  | CRI    | LIGHT OUT | POWER | WIRE THROUGH LINKAB. |
|-------|--------|-----------|-------|----------------------|
| 70090 | >80 Ra | 6120 lm   | 36 W  | No                   |
| 70091 | >80 Ra | 8160 lm   | 48 W  | No                   |
| 70092 | >80 Ra | 6120 lm   | 36 W  | Yes                  |
| 70093 | >80 Ra | 8160 lm   | 48 W  | Yes                  |



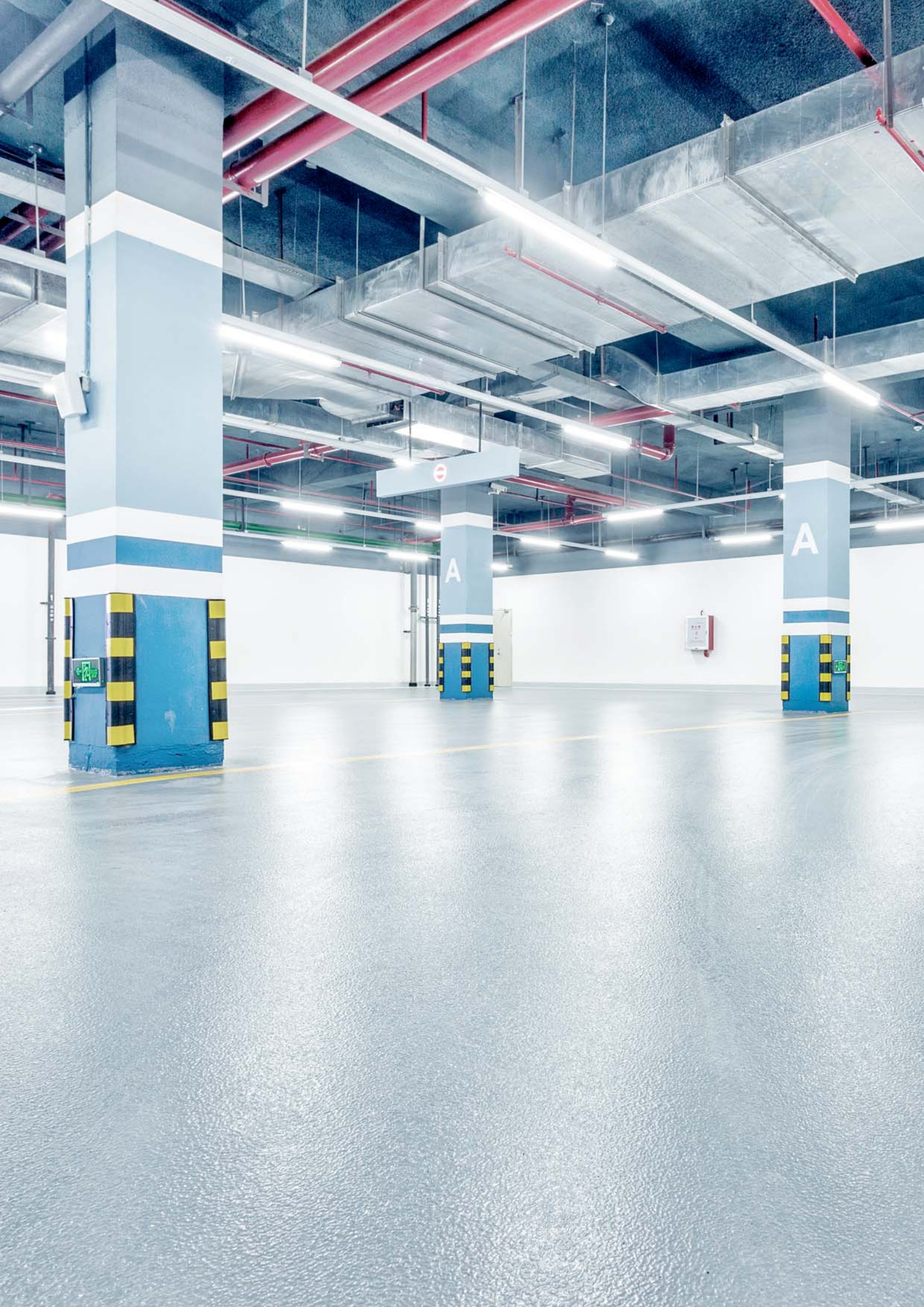



# Damp Proof Housing

## DESCRIPTION

Wired for quick installation of 230V LED tubes.  
 Robust luminaire housing.  
 Easy and fast installation  
 Luminaire housing, available for 1 or 2 T8 LED light sources  
 Protection class: IP65  
 Suitable for SubstiTUBE EM / UN and SubstiTUBE Connected  
 All necessary accessories are included

Certificates: CE/TÜV/SAA/RoHS

Colors: Grey



## AREA OF USE

Replaces fluorescent NCF fittings.  
 Warehouse and factories, car parks, sports facilities and food storage.  
 Outdoor & indoor locations.

|      | A    | B  | C   |
|------|------|----|-----|
| 1xT8 | 600  | 75 | 64  |
| 2xT8 | 600  | 75 | 103 |
| 1xT8 | 1200 | 75 | 64  |
| 2xT8 | 1200 | 75 | 103 |
| 1xT8 | 1500 | 75 | 64  |
| 2xT8 | 1500 | 75 | 103 |

| TYPE  | Name                   | Socket type |
|-------|------------------------|-------------|
| 70100 | 1xT8 Damp Proof 600mm  | G13         |
| 70101 | 2xT8 Damp Proof 600mm  | G13         |
| 70102 | 1xT8 Damp Proof 1200mm | G13         |
| 70103 | 2xT8 Damp Proof 1200mm | G13         |
| 70104 | 1xT8 Damp Proof 1500mm | G13         |
| 70105 | 2xT8 Damp Proof 1500mm | G13         |

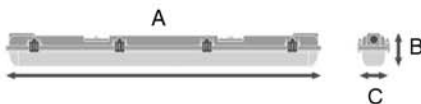

### DESCRIPTION

Industrial Linear Lighting  
Easy wiring, power switchable.

Housing made of die cast aluminium.

Build-in sensor: Motion sensor+Daylight sensor

Emergency battery  
Self-Diagnostic emergency driver: Automatic monthly and annual testing  
Emergency wattage:9W  
Time: 3 hours

Luminous efficacy: 150 Lm/W  
Max. wattage: 150W

Certificates: CE/RoHS/CB

Beam angle 60°/90°/120°

Colors: Light grey



Anti Glare



Ball proof



### AREA OF USE

Warehouse, Factory with sensor, Indoor court

### CAN BE DELIVERED WITH:

Non-Dim or DALI

|         | A    | B   | C  |
|---------|------|-----|----|
| 70880   | 1205 | 107 | 65 |
| 70881-6 | 1460 | 107 | 65 |

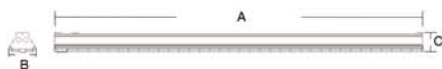

| TYPE  | CRI       | LIGHT OUT | POWER                 | DIMMING                 |
|-------|-----------|-----------|-----------------------|-------------------------|
| 70880 | >80 Ra    | 150 lm/W  | 30-36-45-50W adj.     | Non-Dim                 |
| 70881 | >80 Ra    | 150 lm/W  | 50-58-65-75W adj.     | Non-Dim                 |
| 70882 | >80 Ra    | 150 lm/W  | 100-120-130-150W adj. | Non-Dim                 |
| 70883 | >80 Ra    | 6000 lm   | 40 W                  | DALI                    |
| 70884 | >80 Ra    | 11250 lm  | 75 W                  | DALI                    |
| 70885 | >80 Ra    | 1500 lm   | 100 W                 | DALI                    |
| 70886 | >80 Ra    | 22500 lm  | 150 W                 | DALI                    |
| 70887 | L. 1205mm |           |                       | Grid for Sport lighting |
| 70888 | L. 1460mm |           |                       | Grid for Sport lighting |
| 70889 |           |           |                       | Mounting set            |

# UFO highbay

## DESCRIPTION

Environmental protection: no lead, mercury or other pollution elements Contained, no pollution to the environment;  
 Long service life: 50.000h  
 Unique patented thermal management design to ensure low LED junction temperature.  
 Extremely light weight to enhance the safety use and installation  
 Low power consumption, long lifespan, good stability, high reliability  
 Compared with the filament lamp of the same light effect, 80% reduction in energy consumption.  
 Novel design, elegant and beautiful, with modern lighting features, easy to install and adjust

Certificates: CE/TÜV/SAA/RoHS

Beam angle: 60°/90°/120°



**LED**

**5 YEARS WARRANTY**

**CE**

50000h

L 80  
B 10

MacAdam  
3

IP  
65

ON OFF  
>100000

120-277V  
50/60Hz

## PHOTOMETRIC CURVE

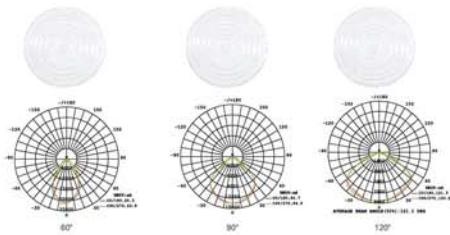

|          | A   | B   | C    | D   |
|----------|-----|-----|------|-----|
| 70-150W  | 138 | 176 | Ø289 | 286 |
| 200-240W | 149 | 187 | Ø325 | 320 |

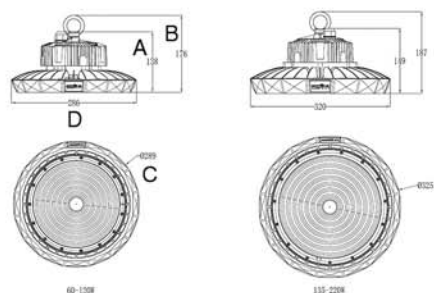

## AREA OF USE

Loading bays & forecourts, factories & warehouses, indoor & outdoor carparks, access areas, sidewalk, etc

Anti-glare cover



Aluminum lampshade 60° 90°



PC lampshade 100°

| TYPE  | CRI    | LIGHT OUT | POWER | COLOR TEMP      |
|-------|--------|-----------|-------|-----------------|
| 70300 | >80 Ra | 12250 lm  | 70 W  | 4000/5000/5700K |
| 70310 | >80 Ra | 15750 lm  | 90 W  | 4000/5000/5700K |
| 70320 | >80 Ra | 19250 lm  | 110 W | 4000/5000/5700K |
| 70330 | >80 Ra | 26250 lm  | 150 W | 4000/5000/5700K |
| 70340 | >80 Ra | 35000 lm  | 200 W | 4000/5000/5700K |
| 70350 | >80 Ra | 42000 lm  | 240 W | 4000/5000/5700K |



## DESCRIPTION

This high bay is designed with large size but light-weight. Heat sink helps the body better heat dissipation, and makes sure lifespan. Multiple beam angles adjustable for different installation height. Lumen output is selectable, one fixture for four wattage. UFO Galaxy is suitable for both wholesales and contract channel. PC and ALU Reflectors are available. Compatible with PIR & Microwave motion sensor

Luminous efficacy 150lm/W

Certificates: CE/SAA/RoHS

Colors: Black

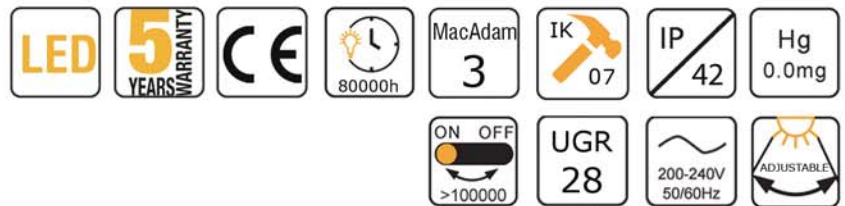

## PHOTOMETRIC CURVE

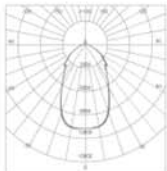

NARROW

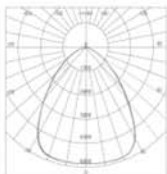

MEDIUM

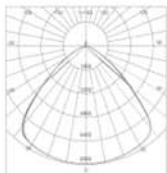

WIDE

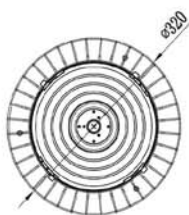

## AREA OF USE

Warehouse, Industrial Facility, Exhibition Center, Shopping Mall, Gymnasium, Airport, Toll Station etc.

## CAN BE DELIVERED WITH:

4000K/5000K (3000K optional)

| TYPE  | CRI   | POWER            | LIGHT OUT     | COLOR TEMP |
|-------|---|------------------|---------------|------------|
| 70361 | >80 Ra  | 100-120-150-200W | 15000-30000lm | 4000K      |
| 70362 | >80 Ra  | 100-120-150-200W | 15000-30000lm | 5000K      |
| 70363 | UFO Galaxy PC Reflector                         |                  |               |            |
| 70364 | UFO Galaxy Alu Reflector 65 deg.                |                  |               |            |
| 70365 | UFO Galaxy Plug and Play Motion sensor 100-200W |                  |               |            |
| 70366 | UFO Galaxy Plug and Play PIR sensor 100-200W    |                  |               |            |
| 70367 | UFO Galaxy Remote control                       |                  |               |            |
| 70368 | UFO Galaxy PC Cover for Reflector               |                  |               |            |
| 70369 | UFO Galaxy Alu Reflector 90deg                  |                  |               |            |

# Flood Light

## DESCRIPTION

Full waterproof design.

Multi-Chip on lead frame, single module LED package design. System design integrating power supply, LED light engine and heat sink.

Over Current, Over Voltage, Over Heat, Thunder Protection  
Fast response (no delay), No mercury vapour, No radiation.

Billboard support (for mounting the floodlight) is available on request.

The floodlight can mounted on the roof, wall, ground etc. Wire out from vacancy of the support end.

Certificates: CE/TÜV/SAA/RoHS

Colors: Black



|            |                         |           |        |              |                   |            |             |
|------------|-------------------------|-----------|--------|--------------|-------------------|------------|-------------|
| <b>LED</b> | <b>5 YEARS WARRANTY</b> | <b>CE</b> | 50000h | L 80<br>B 10 | MacAdam<br><4     | IP<br>65   | Hg<br>0.0mg |
|            |                         |           |        |              | ON OFF<br>>100000 | 80%<br>≤1S | 120°        |

## PHOTOMETRIC CURVE

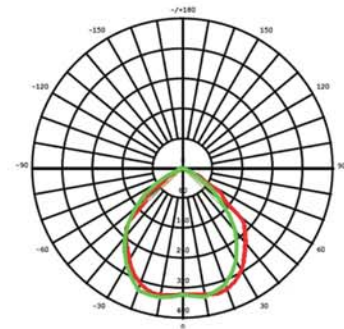

|       | A   | B   | C   | D  |
|-------|-----|-----|-----|----|
| 70900 | 188 | 132 | 112 | 45 |
| 70910 | 234 | 182 | 150 | 52 |
| 70920 | 278 | 230 | 195 | 62 |
| 70930 | 362 | 286 | 236 | 70 |

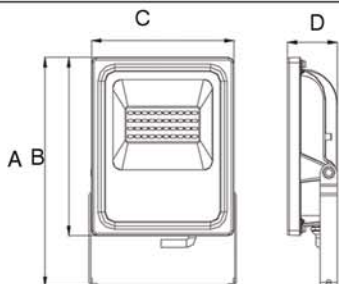

## AREA OF USE

Loading bays & forecourts, factories & warehouses, indoor & outdoor carparks, access areas, roadway, pathway, sidewalk etc.

| TYPE  | CRI    | LIGHT OUT | POWER | COLOR TEMP |
|-------|--------|-----------|-------|------------|
| 70900 | >80 Ra | 700 lm    | 10 W  | 3000K      |
| 70910 | >80 Ra | 1500 lm   | 20 W  | 3000K      |
| 70920 | >80 Ra | 2250 lm   | 30 W  | 3000K      |
| 70930 | >80 Ra | 3750 lm   | 50 W  | 3000K      |
| 70940 | >80 Ra | 7500 lm   | 100 W | 3000K      |
| 70950 | >80 Ra | 11250 lm  | 150 W | 3000K      |

# HiSpot Flood Light

## DESCRIPTION

Designed for small and medium sized stadiums and plaza applications

Aerodynamic flow

The radiator is so effective that it allows the air to circulate without producing any resistance

10KV Surge Protection  
Corrosion resistant

Certificates: CE/SAA/RoHS

Colors: Black



|            |                         |           |        |                            |                         |                        |                        |
|------------|-------------------------|-----------|--------|----------------------------|-------------------------|------------------------|------------------------|
| <b>LED</b> | <b>5 YEARS WARRANTY</b> | <b>CE</b> | 50000h | <b>L 80</b><br><b>B 10</b> | MacAdam<br><b>&lt;5</b> | <b>IP</b><br><b>66</b> | Hg<br>0.0mg            |
|            |                         |           |        |                            |                         |                        | <b>IK</b><br><b>08</b> |

## PHOTOMETRIC CURVE

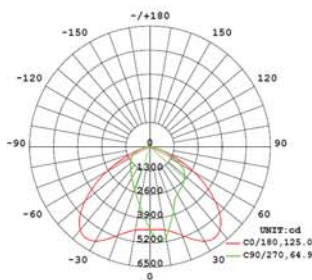

|          | A   | B   | C  |
|----------|-----|-----|----|
| 40-80W   | 359 | 308 | 82 |
| 100-150W | 413 | 366 | 83 |
| 180-240W | 462 | 452 | 87 |

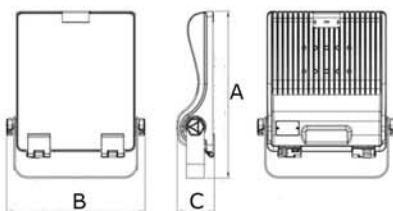

## AREA OF USE

For recreational sports, tennis courts, basketball courts, billboard lighting, parking lots etc.

## CAN BE DELIVERED WITH

3000K  
5000K

| TYPE  | CRI    | LIGHT OUT | POWER | COLOR TEMP |
|-------|--------|-----------|-------|------------|
| 71000 | >80 Ra | 5400 lm   | 40 W  | 4000K      |
| 71010 | >80 Ra | 8100 lm   | 60 W  | 4000K      |
| 71020 | >80 Ra | 10800 lm  | 80 W  | 4000K      |
| 71030 | >80 Ra | 13500 lm  | 100 W | 4000K      |
| 71040 | >80 Ra | 16200 lm  | 120 W | 4000K      |
| 71050 | >80 Ra | 20250 lm  | 150 W | 4000K      |
| 71060 | >80 Ra | 24300 lm  | 180 W | 4000K      |
| 71070 | >80 Ra | 27000 lm  | 200 W | 4000K      |
| 71080 | >80 Ra | 32400 lm  | 240 W | 4000K      |



# HiMast Flood light

LED INDUSTRIAL LIGHTING OUTDOOR LIGHTING

## DESCRIPTION

HiMast comes with a waterproof rubber ring inside. And its well-designed radiating fins help accelerate airflow and avoid water accumulating. Each LED module is equipped with a respirator to prevent water vapor. Additionally, HiMast gets IK08 impact-resistant grade, which provides better protection for outdoor usage.

HiMast adopts small beam angle optics (18° and 30°). And with the high efficacy 130lm/W, it can reach a quite far target lighting area as wished.

Each module (300W) is made by aluminum alloy with superior heat dissipation performance, and tempered glass, and plug-and-play waterproof cable connector. Installation can be finished just by using a 6mm hexagonal screwdriver.

Certificates: CE/SAA/RoHS

Colors: Black



|            |                         |           |        |                            |                         |                        |             |                 |
|------------|-------------------------|-----------|--------|----------------------------|-------------------------|------------------------|-------------|-----------------|
| <b>LED</b> | <b>5 YEARS WARRANTY</b> | <b>CE</b> | 50000h | <b>L 80</b><br><b>B 10</b> | MacAdam<br><b>&lt;5</b> | <b>IP</b><br><b>66</b> | Hg<br>0.0mg | <b>IK</b><br>08 |
|------------|-------------------------|-----------|--------|----------------------------|-------------------------|------------------------|-------------|-----------------|

## PHOTOMETRIC CURVE

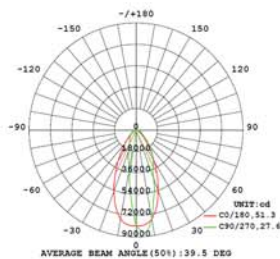

|       | A   | B   | C   |
|-------|-----|-----|-----|
| 71100 | 525 | 288 | 173 |
| 71110 | 564 | 598 | 401 |
| 71120 | 792 | 598 | 401 |

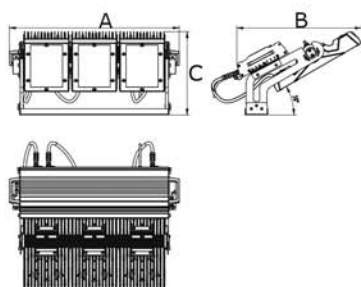

## AREA OF USE

For outdoor use. Football stadiums, training courses, running tracks etc.

## CAN BE DELIVERED WITH

3000K  
5000K

| TYPE  | CRI    | LIGHT OUT  | POWER | COLOR TEMP |
|-------|--------|------------|-------|------------|
| 71100 | >80 Ra | 39.000 lm  | 300 W | 4000K      |
| 71110 | >80 Ra | 78.000 lm  | 600 W | 4000K      |
| 71120 | >80 Ra | 117.000 lm | 900 W | 4000K      |

# HiSmooth Street Light

**DESCRIPTION**

**Smooth Design**

Smooth body would not accumulate dust, sand, or other solid material, and would minimize environment impact for fixture performance.

**Surface Treatment**

Anti-static and anti-UV outdoor using powder coating

**Easy Maintenance**

Buckle for fixing heat sink could be opened without tools. There is a supporting bracket to hold upper and lower parts of fixture body, when electricians open for maintaining.

**Easy Replacement for LED Driver**

The LED driver is fixed by buckles, can be installed or removed easily

**Power-off Protection**

Power would automatically be off once the fixture body opened.

Color: Silver



**PHOTOMETRIC CURVE**

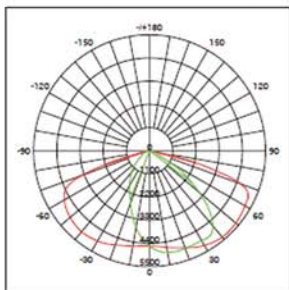

|          | A   | B   | C   |
|----------|-----|-----|-----|
| 71200-30 | 763 | 352 | 617 |
| 71240-90 | 680 | 282 | 533 |

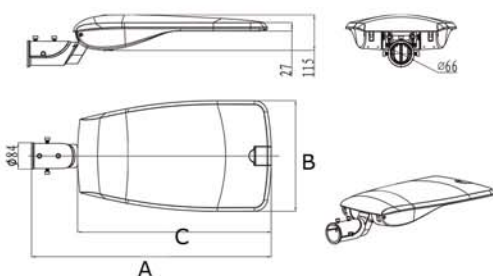

**AREA OF USE**

Suitable for wide range of road applications. For main roads, collecting roads, roundabouts

**CAN BE DELIVERED WITH**

3000K, 5000K  
Daylight sensor, Time control, Solar control

**ACCESSORIES**

Spigot 76/90mm  
Twin bracket



| TYPE  | CRI    | LIGHT OUT | POWER | COLOR TEMP |
|-------|--------|-----------|-------|------------|
| 71200 | >70 Ra | 3750 lm   | 30 W  | 4000K      |
| 71210 | >70 Ra | 6000 lm   | 50 W  | 4000K      |
| 71220 | >70 Ra | 8400 lm   | 70 W  | 4000K      |
| 70230 | >70 Ra | 9900 lm   | 90 W  | 4000K      |
| 70240 | >70 Ra | 3900 lm   | 30 W  | 4000K      |
| 70250 | >70 Ra | 6500 lm   | 50 W  | 4000K      |
| 70260 | >70 Ra | 9100 lm   | 70 W  | 4000K      |
| 70270 | >70 Ra | 11700 lm  | 90 W  | 4000K      |
| 70280 | >70 Ra | 15600 lm  | 120 W | 4000K      |
| 70290 | >70 Ra | 18750 lm  | 150 W | 4000K      |





# HiSmooth Street Light 15 Watt

**DESCRIPTION**

**Smooth Design**

Smooth body would not accumulate dust, sand, or other solid material, and would minimize environment impact for fixture performance.

**Surface Treatment**

Anti-static and anti-UV outdoor using powder coating

**Easy Maintenance**

Buckle for fixing heat sink could be opened without tools. There is a supporting bracket to hold upper and lower parts of fixture body, when electricians open for maintaining.

**Easy Replacement for LED Driver**

The LED driver is fixed by buckles, can be installed or removed easily

**Power-off Protection**

Power would automatically be off once the fixture body opened.

Color: Silver

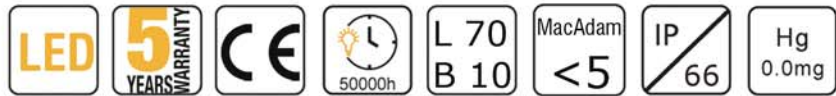

**PHOTOMETRIC CURVE**

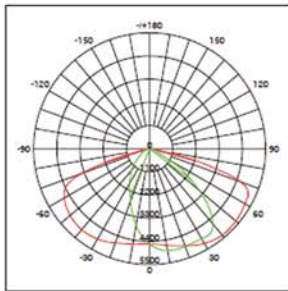

|             | A   | B   | C   |
|-------------|-----|-----|-----|
| 71292/95/98 | 613 | 222 | 159 |

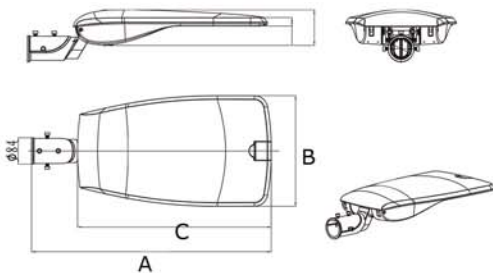

**AREA OF USE**

Suitable for wide range of road applications. For main roads, collecting roads, roundabouts

**CAN BE DELIVERED WITH**

3000K, 5000K  
Daylight sensor, Time control, Solar control

**ACCESSORIES**

Spigot 76/90mm  
Twin bracket



| TYPE  | CRI    | LIGHT OUT | POWER | COLOR TEMP |
|-------|--------|-----------|-------|------------|
| 71292 | >70 Ra | 1875 lm   | 15 W  | 4000K      |
| 71295 | >70 Ra | 2500 lm   | 20 W  | 4000K      |
| 71298 | >70 Ra | 3750 lm   | 30 W  | 4000K      |



## DESCRIPTION

Bollard lights are one of the most attractive lighting options available to homes and businesses for landscape lighting as they are offered in a variety of styles, colors, and materials. Whether you are looking to add attractive ambient lighting to your property, improve your home security by increasing visibility, or to mark walkways, driveways and pathways.

Certificates: CE/TÜV/RoHS

Color: Black

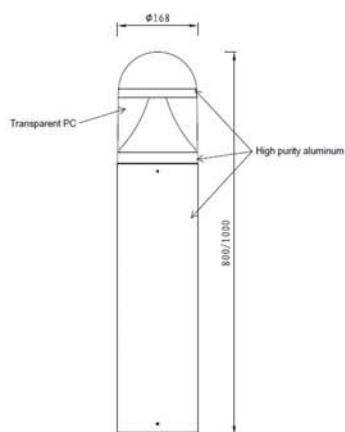

## AREA OF USE

Walkways, Driveways, Pathways

|       | A   | B   | C    |
|-------|-----|-----|------|
| 71400 | 168 | 168 | 1000 |

| TYPE  | CRI    | LIGHT OUT | POWER | COLOR TEMP |
|-------|--------|-----------|-------|------------|
| 71400 | >70 Ra | 1650 lm   | 25 W  | 4000K      |

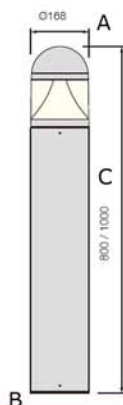







## DESCRIPTION

Bollard lights are one of the most attractive lighting options available to homes and businesses for landscape lighting as they are offered in a variety of styles, colors, and materials. Whether you are looking to add attractive ambient lighting to your property, improve your home security by increasing visibility, or to mark walkways, driveways and pathways.

Certificates: CE/TÜV/RoHS

Color: Grey

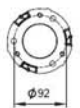
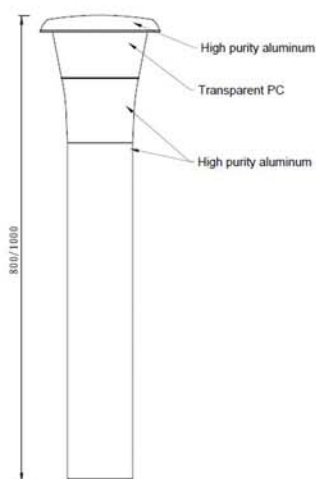

Installation template

|       | A   | B   | C    |
|-------|-----|-----|------|
| 71500 | 217 | 118 | 800  |
| 71510 | 217 | 118 | 1000 |

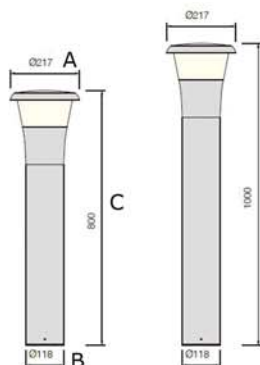

**LED**

**3**  
YEARS  
WARRANTY

**CE**

30000h

L 50  
B 50

MacAdam  
4

IP  
65

Hg  
0.0mg

IK  
09

## AREA OF USE

Walkways, Driveways, Pathways

## CAN BE DELIVERED WITH

2700K/3000K/4000K/5700K

| TYPE  | CRI    | LIGHT OUT | POWER | COLOR TEMP |
|-------|--------|-----------|-------|------------|
| 71500 | >70 Ra | 840 lm    | 12 W  | 4000K      |
| 71510 | >70 Ra | 840 lm    | 12 W  | 4000K      |





**DESCRIPTION**

Decorative LED luminaire for 3-6 meters mast fitted with Osram 4DIM driver has both ENEC and VDE certificates. With the Osram 4DIM driver, the PARK LAMP is astronomical clock that automatically adapts day and night. With this function, the best savings are achieved with a night reduction of 50%  
Energy class: A+

Beam angle: 360°

Certificates: CE/ENEC/VDE

Colors: Grey



**AREA OF USE**

Suitable for parking spaces, walking paths and parks

|       |     |     |
|-------|-----|-----|
|       | A   | B   |
| 71800 | 635 | 500 |

| TYPE  | CRI    | LIGHT OUT | POWER | COLOR TEMP |
|-------|--------|-----------|-------|------------|
| 71800 | >80 Ra | 3000 lm   | 30 W  | 4000K      |

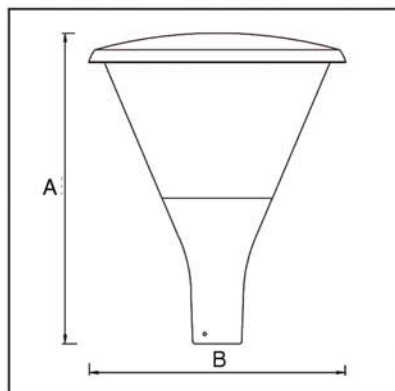

# Pullert F

## DESCRIPTION

Bollard lights are one of the most attractive lighting options available to homes and businesses for landscape lighting as they are offered in a variety of styles, colors, and materials. Whether you are looking to add attractive ambient lighting to your property, improve your home security by increasing visibility, or to mark walkways, driveways and pathways.

Certificates: CE/TÜV/RoHS

Color: Black

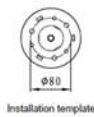
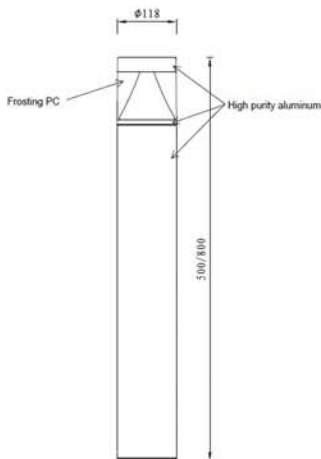

|       | A   | B   |
|-------|-----|-----|
| 71300 | 118 | 800 |

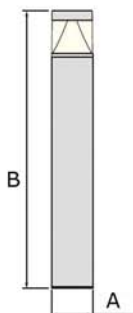

**LED**

**3**  
YEARS  
WARRANTY

**CE**

30000h

**L 50**  
**B 50**

MacAdam  
**4**

**IP**  
**65**

Hg  
0.0mg

IK  
08

## AREA OF USE

Walkways, driveways, pathways etc.

| TYPE  | CRI    | LIGHT OUT | POWER | COLOR TEMP |
|-------|--------|-----------|-------|------------|
| 71300 | >75 Ra | 800 lm    | 9 W   | 4000K      |

**DESCRIPTION**

Outdoor floodlight for commercial signs, a classical European design with asymmetric light distribution  
The floodlight can be mounted on the roof or wall.  
Aluminium housing  
Rod to be used for wallmounting: D. 20xL 495mm, aluminium.

Certificates: CE

Asymmetric beam angle  
105°x90°

Colors: White/black

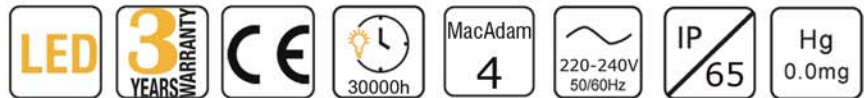

**AREA OF USE**

Factories and warehouses etc.

**CAN BE DELIVERED WITH:**

3000K

|       | A   | B   | C  |
|-------|-----|-----|----|
| 71900 | 168 | 138 | 60 |

| TYPE  | CRI   | LIGHT OUT | POWER | COLOR TEMP |
|-------|-------|-----------|-------|------------|
| 71900 | 80 Ra | 2300 lm   | 18 W  | 3000-4000K |



# Floodlight Facade

## DESCRIPTION

An integrated solution for floodlight and Arm

System Efficiency 120-130 Lm/W

Class II double isolation design

ADC12 die-casting Al body, stainless steel screws, good corrosion resistance.

Light source 32xLuxeon 3030

Certificates: CE/RoHS

Colors: Black



|            |                         |           |        |                |           |                    |          |
|------------|-------------------------|-----------|--------|----------------|-----------|--------------------|----------|
| <b>LED</b> | <b>5 YEARS WARRANTY</b> | <b>CE</b> | 50000h | ON OFF >100000 | IK 08     | IP 66              | Hg 0.0mg |
|            |                         |           |        |                | MacAdam 4 | 100-240VAC 50/60Hz | 120°     |

## PHOTOMETRIC CURVE

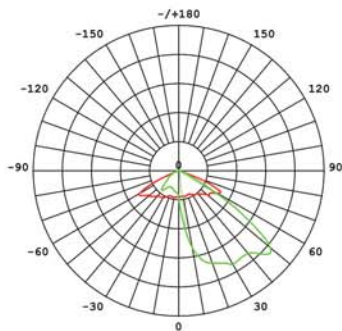

## AREA OF USE

Suitable for general lighting and decoration lighting such as Garden, Building decoration, Billboard, Warehouse, Gas station, Tool Stations etc.

## CAN BE DELIVERED WITH:

3000K/4000K/5700K

| TYPE  | CRI    | POWER | LIGHT OUT | COLOR TEMP |
|-------|--------|-------|-----------|------------|
| 71910 | >70 Ra | 16 W  | 2000Lm    | 4000K      |

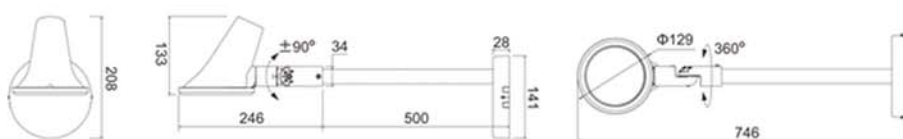



## Trunk System

Lumen output  
Max. 9600 Lm

Page 148



## Trunk Accessories

Page 149

LED TRUNK

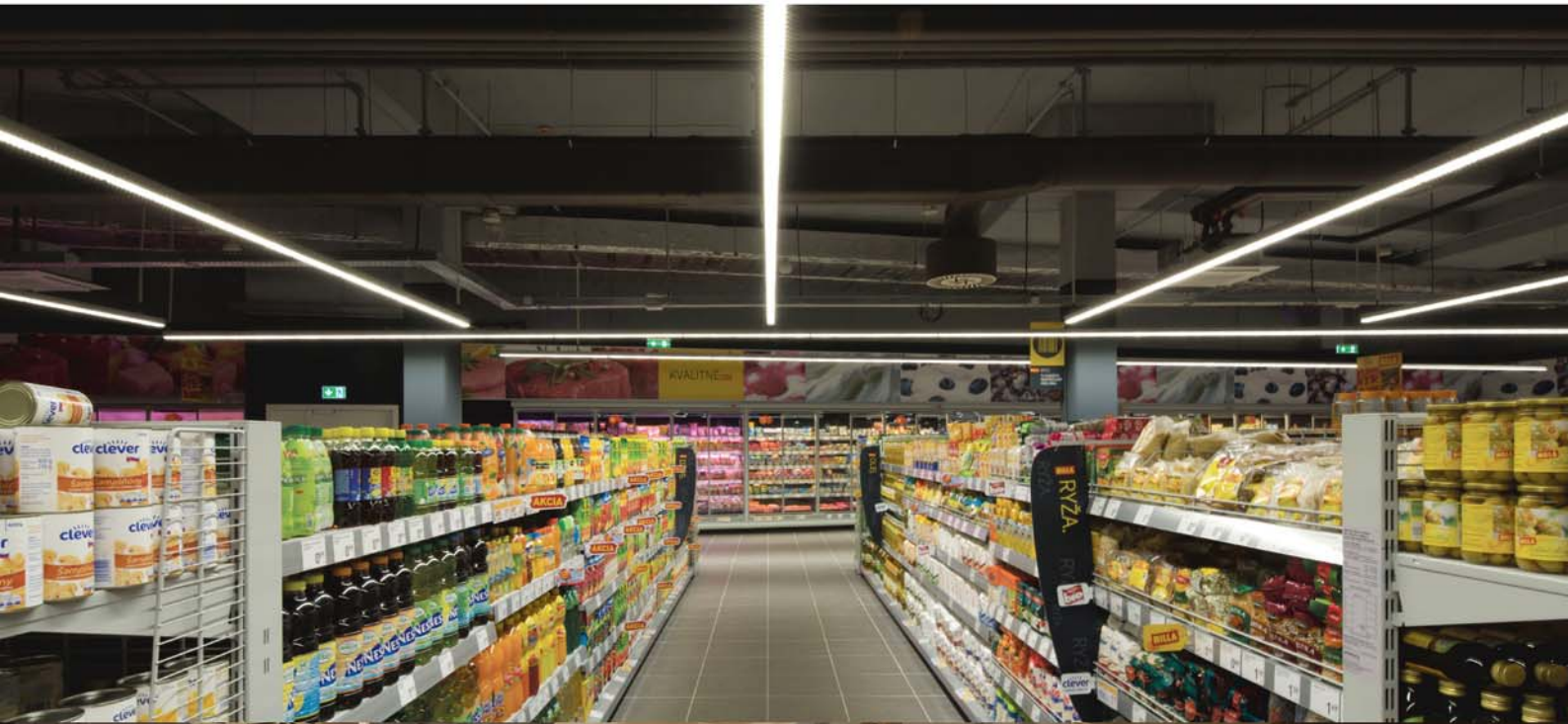



# TRUNK SYSTEM LED

## DESCRIPTION

Mounting: Suspended or ceiling surfaced  
 - determined for continuous installation.  
 Light source: LED  
 Optical system  
 Wiring: Electronic control gear FIX/DALI  
 Emergency unit variant  
 Housing: sheet steel  
 Reflector: polished anodised aluminium  
 Cover: transparent PMMA  
 Ambient temperature: From -25 °C to +35 °C  
 from 0°C with EM unit

Colors: White



LED TRUNK

|     |                  |    |        |              |                   |            |                     |
|-----|------------------|----|--------|--------------|-------------------|------------|---------------------|
| LED | 5 YEARS WARRANTY | CE | 50000h | L 70<br>B 50 | MacAdam<br>3      | IP<br>20   | Hg<br>0.0mg         |
|     |                  |    |        |              |                   |            |                     |
|     |                  |    |        |              | ON OFF<br>>100000 | 80%<br>≤1S | 220-240V<br>50/60Hz |

## AREA OF USE

Education, sport, leisure, presentation, industry and engineering

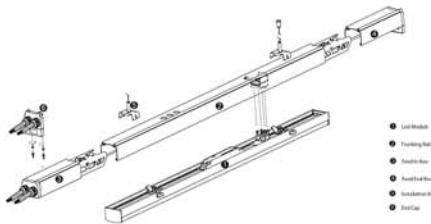

|       | A    | B  | C  |
|-------|------|----|----|
| 80000 | 578  | 84 | 45 |
| 80010 | 1437 | 84 | 45 |
| 80020 | 2874 | 84 | 45 |

| TYPE  | CRI   | LIGHT OUT | POWER        | COLOR TEMP. |
|-------|-------|-----------|--------------|-------------|
| 80000 | 80 Ra | 160lm/W   | 32/42/50/60W | 3/4/5/6500K |
| 80010 | 80 Ra | 160lm/lm  | 32/42/50/60W | 3/4/5/6500K |
| 80020 | 80 Ra | 160lm/W   | 32/42/50/60W | 3/4/5/6500K |

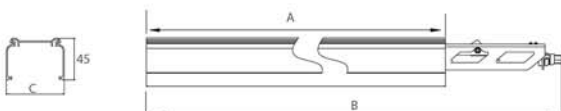



| ART. NO. | PRODUCT NAME                | PHOTO  |
|----------|-----------------------------|--|
| 80030    | Feed End Box                |    |
| 80031    | Feed IN Box                 |    |
| 80032    |                             |    |
| 80033    |                             |    |
| 80034    |                             |    |
| 80035    | Adjustable L-corner         |    |
| 80036    | Steel cable suspension kits |   |
| 80037    | Chain suspension kits       |  |
| 80038    |                             |  |
| 80039    | End Cap                     |  |



**Eco Slim**

Lumen output  
Max. 1500 Lm

Page 151



**Strips**

Lumen output  
Max. 1600 Lm

Page 159



**Diva 2 HO**

Lumen output  
Max. 1972 Lm

Page 153



**Profiles AR**

Page 160



**Diva 2**

Lumen output  
Max. 1050 Lm

Page 154



**Goal**

Lumen output  
Max. 1200 Lm

Page 161



**Diva 2 Spot Swivel**

Lumen output  
Max. 336Lm

Page 153



**Diamond Kit**

Page 162



**Diva 2 Spot**

Lumen output  
Max. 336 Lm

Page 154



**Sigma Micro**

Lumen output  
Max. 250 Lm

Page 163



**Flexible Neon 1**

Lumen output  
Max. 135 Lm

Page 157



**Flexible Neon 2**

Lumen output  
Max. 255 Lm

Page 158

## DESCRIPTION

LED efficiency for cove, under cabinet and mil work at a fluorescent price.

AC Power driver built in (SMPS not needed)

Dark spot free at the linking point

Class I

Max. connection: 400W

(5W/72 pcs, 10W/40pcs,

15W/26 pcs., 20W/20pcs

Energi efficiency 75 lm/W

Available color 3000K, 4000K

Certificates: CE/ETL/CCC

Colors: White

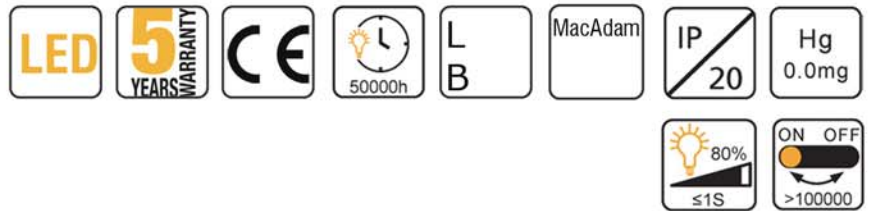

## AREA OF USE

Shops, office, restaurant and other public places

|       | A    | B  | C  |
|-------|------|----|----|
| 90000 | 304  | 23 | 31 |
| 90010 | 565  | 23 | 31 |
| 90020 | 865  | 23 | 31 |
| 90030 | 1165 | 23 | 31 |

| TYPE  | CRI    | LIGHT OUT | POWER | COLOR TEMP |
|-------|--------|-----------|-------|------------|
| 90000 | >80 Ra | 375 lm    | 5 W   | 3000K      |
| 90010 | >80 Ra | 750 lm    | 10 W  | 3000K      |
| 90020 | >80 Ra | 1125 lm   | 15 W  | 3000K      |
| 90030 | >80 Ra | 1500 lm   | 20 W  | 3000K      |

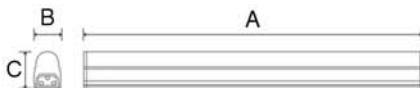





## DESCRIPTION

Super Slim liner LED with high output.

Quick connection system between fixtures.

Many lengths available.

Various mounting methods including magnetic.

To be used with constant voltage DC 24V driver.

Dimmable with available accessories.

Maximum Connection: 75 Watts in one row.

Energy efficiency : 85lm/W

Certificates: CE/ETL/CCC

Colors: White

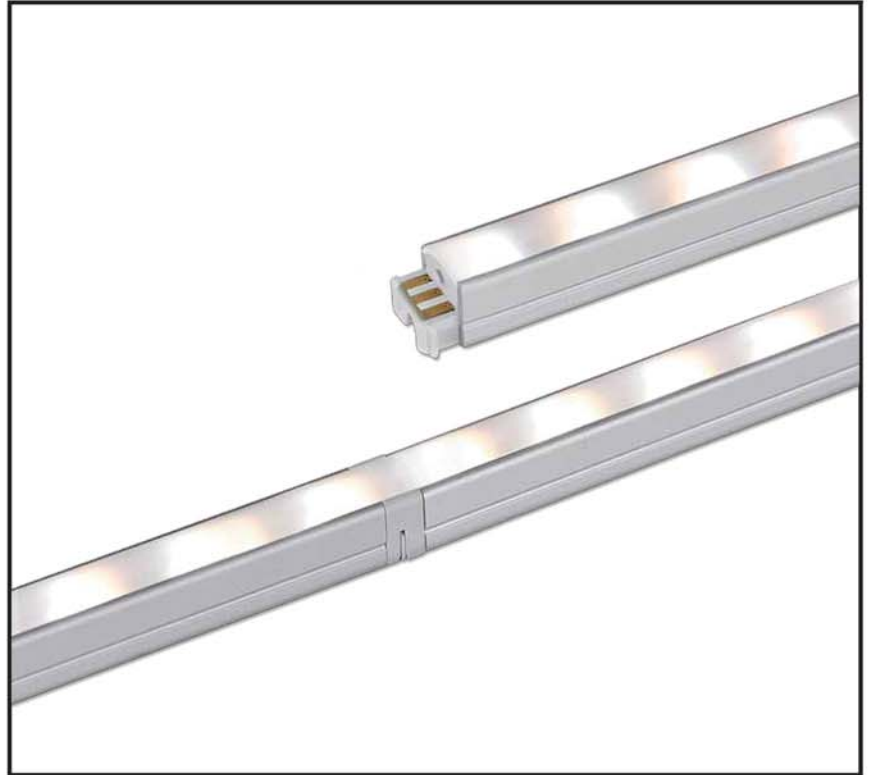

## AREA OF USE

Display windows, shops and other public places

## CAN BE DELIVERED WITH:

2700K, 3000K, 3500K, 4000K, 6000K

|       | A    | B    | C    |
|-------|------|------|------|
| 90200 | 140  | 145  | 162  |
| 90210 | 280  | 285  | 302  |
| 90220 | 560  | 565  | 582  |
| 90230 | 840  | 845  | 862  |
| 90240 | 1118 | 1123 | 1140 |

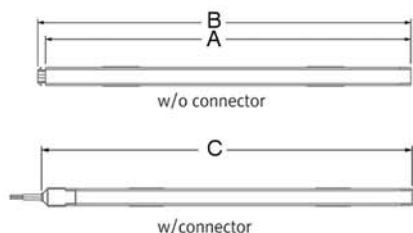

| TYPE  | CRI    | LIGHT OUT | POWER | COLOR TEMP |
|-------|--------|-----------|-------|------------|
| 90200 | >85 Ra | 246 lm    | 3 W   | 3000K      |
| 90210 | >85 Ra | 493 lm    | 6 W   | 3000K      |
| 90220 | >85 Ra | 986 lm    | 12 W  | 3000K      |
| 90230 | >85 Ra | 1479 lm   | 18 W  | 3000K      |
| 90240 | >85 Ra | 1972 lm   | 23 W  | 3000K      |

# Diva 2

## DESCRIPTION

Super Slim linear LED with standard output.  
 Quick connection system between fixtures.  
 Different lengths available for optimal installation flexibility.  
 Various mounting methods including magnetic attachment.  
 To be used with constant voltage DC 24V driver.  
 Dimmable with available accessories.  
 Maximum Connection: 55 Watts in one row.  
 Energy efficiency: 75lm/W.

Certificates: CE/ETL/CCC

Colors: White

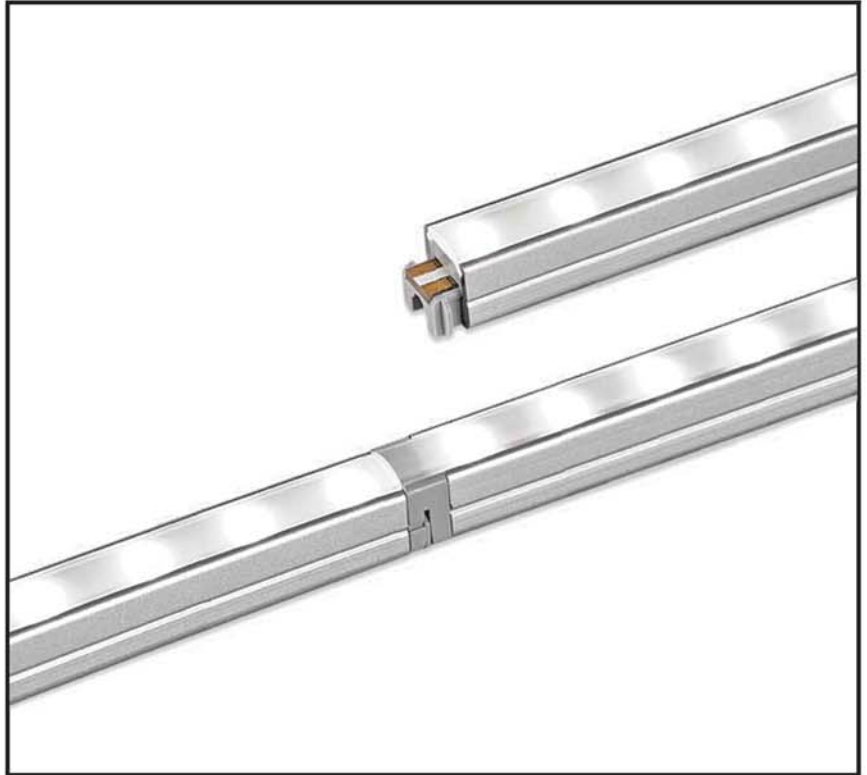

LED SLIM TRACKS/  
CABINET LIGHTING

|            |                         |           |        |                            |                      |                   |                 |
|------------|-------------------------|-----------|--------|----------------------------|----------------------|-------------------|-----------------|
| <b>LED</b> | <b>5 YEARS WARRANTY</b> | <b>CE</b> | 50000h | <b>L 70</b><br><b>B 50</b> | MacAdam <b>&lt;3</b> | <b>IP 20</b>      | Hg <b>0.0mg</b> |
|            |                         |           |        |                            |                      | ON OFF<br>>100000 | 80%<br>≤1S      |

## AREA OF USE

Display windows, shops and other public places

## CAN BE DELIVERED WITH:

2700K, 3000K, 3500K, 4000K, 6000K

|       | A    | B    | C    |
|-------|------|------|------|
| 90300 | 95   | 100  | 117  |
| 90310 | 188  | 192  | 210  |
| 90320 | 280  | 285  | 302  |
| 90330 | 560  | 565  | 582  |
| 90340 | 840  | 845  | 862  |
| 90350 | 1118 | 1123 | 1140 |

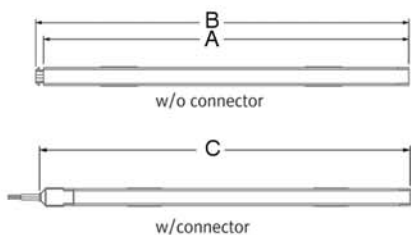

| TYPE  | CRI    | LIGHT OUT | POWER | COLOR TEMP |
|-------|--------|-----------|-------|------------|
| 90300 | >85 Ra | 90 lm     | 1 W   | 3000K      |
| 90310 | >85 Ra | 180 lm    | 2 W   | 3000K      |
| 90320 | >85 Ra | 262 lm    | 4 W   | 3000K      |
| 90340 | >85 Ra | 525 lm    | 7 W   | 3000K      |
| 90350 | >85 Ra | 788 lm    | 11 W  | 3000K      |
| 90360 | >85 Ra | 1050 lm   | 14 W  | 3000K      |



## Diva 2 Spot Swivel

**DESCRIPTION**

Directly linkable to FLX series  
 Single 4W diode eliminates multiple shadows.  
 Virtually zero heat emission and UV radiation.  
 To be used with constant voltage DC 24V driver.  
 Dimmable with available accessories.  
 Energy efficiency : 80lm/W  
 Max 7pcs in a row

Certificates: CE/ETL/CCC

Beam angle 60°

Colors: White/silver/gold/black



LED SLIM TRACKS/  
CABINET LIGHTING

|     |                  |    |        |              |                |         |          |
|-----|------------------|----|--------|--------------|----------------|---------|----------|
| LED | 5 YEARS WARRANTY | CE | 50000h | L 70<br>B 50 | MacAdam <3     | IP 20   | Hg 0.0mg |
|     |                  |    |        | 68mm Cutout  | ON OFF >100000 | 80% ≤1S |          |

**AREA OF USE**

Display windows, shops and other public places

**CAN BE DELIVERED WITH:**

3000K, 4000K, 6000K

|       | A | B  | C  |
|-------|---|----|----|
| 90800 | 2 | 16 | 76 |
| 90810 | 2 | 16 | 76 |

| TYPE  | CRI    | LIGHT OUT | POWER | COLOR TEMP |
|-------|--------|-----------|-------|------------|
| 90800 | >85 Ra | 336 lm    | 4 W   | 3000K      |
| 90810 | >85 Ra | 336 lm    | 4 W   | 3000K      |

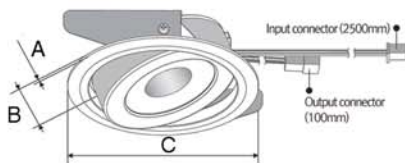

### DESCRIPTION

Linkable together with FLX series.  
 Single 4W diode eliminates multiple shadows.  
 Virtually no heat emission and no UV radiation.  
 Friction fit in slim pocket with mounting spring option.  
 To be used with constant voltage DC 24V driver.  
 Dimmable with available accessories.  
 Energy efficiency : 80lm/W  
 Max 7pcs in a row

Certificates: CE/ETL/CCC

Beam angle 60°

Colors: White/silver/gold/black



### AREA OF USE

Display windows, shops and other public places

### CAN BE DELIVERED WITH:

3000K, 4000K, 6000K

|       | A | B  | C  |
|-------|---|----|----|
| 90900 | 2 | 16 | 76 |
| 90910 | 2 | 16 | 76 |

| TYPE  | CRI    | LIGHT OUT | POWER | COLOR TEMP |
|-------|--------|-----------|-------|------------|
| 90900 | >85 Ra | 336 lm    | 4 W   | 3000K      |
| 90910 | >85 Ra | 336 lm    | 4 W   | 3000K      |

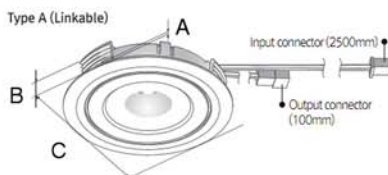

## DESCRIPTION

Seamless Spot Free Illumination  
Ultra Slim  
Close Pitch LEDs  
Bend Direction Horizontally  
Dimmable with 0-10V,  
Forward/Reverse Phase  
Indoor and Outdoor Application  
8 Colors Available  
Available in Standard Lengths  
of 1,2,3,4,5M Reels

Energy efficiency : 85lm/W

Certificates: CE/ETL/CCC

Colors: White

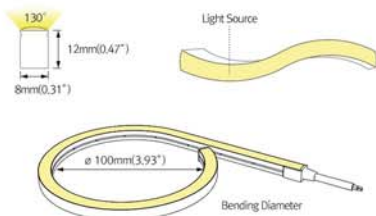
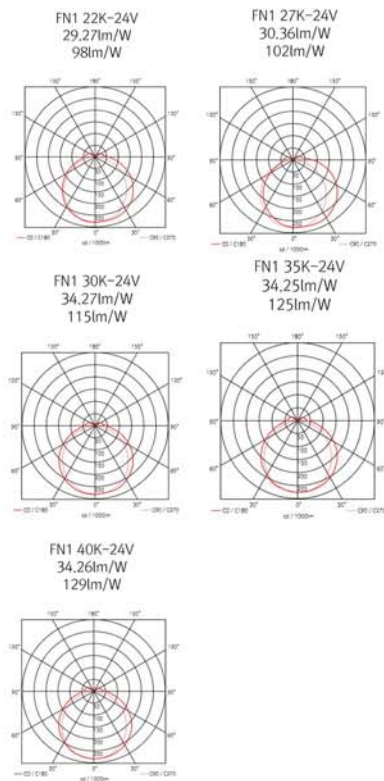

**LED**

**5**  
YEARS  
WARRANTY

**CE**

50000h

**L 70**  
**B 50**

MacAdam  
**3**

**IP**  
**65**

Hg  
0.0mg

ON OFF  
  
>100000

80%  
≤1S

## AREA OF USE

Display windows, shops and other public places

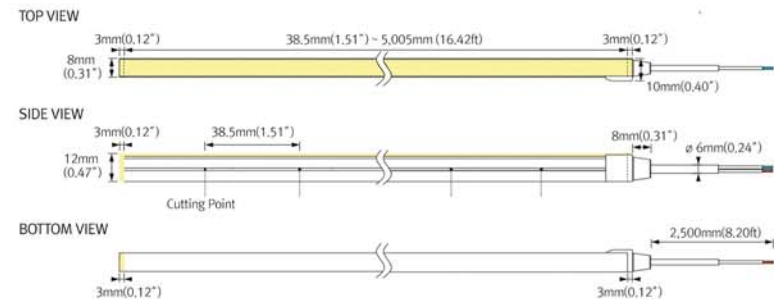

| TYPE  | CRI   | LIGHT OUT | POWER | COLOR TEMP |
|-------|-------|-----------|-------|------------|
| 91000 | 80 Ra | 109 lm    | 3,8 W | 2200K      |
| 91010 | 80 Ra | 114 lm    | 3,8 W | 2700K      |
| 91020 | 80 Ra | 126 lm    | 3,8 W | 3000K      |
| 91030 | 80 Ra | 135 lm    | 3,8 W | 3500K      |
| 91040 | 80 Ra | 135 lm    | 3,8 W | 4000K      |



# Flexible Neon 2

## DESCRIPTION

Seamless Spot Free Illumination  
 Ultra Slim  
 Close Pitch LEDs  
 Bend Direction Horizontally  
 Dimmable with 0-10V,  
 Forward/Reverse Phase  
 Indoor and Outdoor Application  
 8 Colors Available  
 Available in Standard Lengths  
 of 1,2,3,4,5M Reels

Energy efficiency : 85lm/W

Certificates: CE/ETL/CCC

Colors: White

LED SLIM TRACKS/  
CABINET LIGHTING

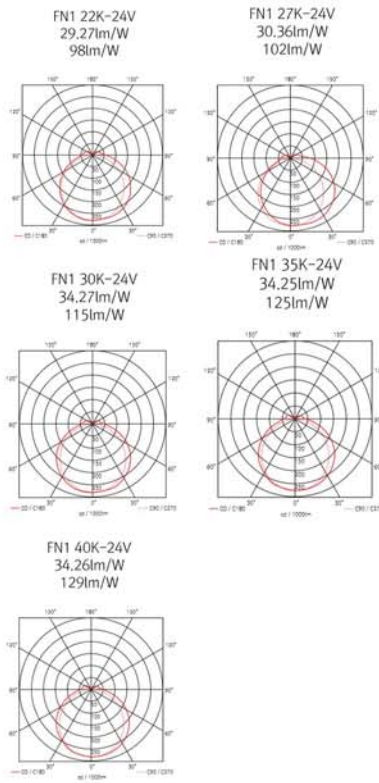

LED 5 YEARS WARRANTY CE 50000h L70 B50 MacAdam 3 IP65 Hg 0.0mg ON/OFF >100000 80% ≤1S

## AREA OF USE

Display windows, shops and other public places

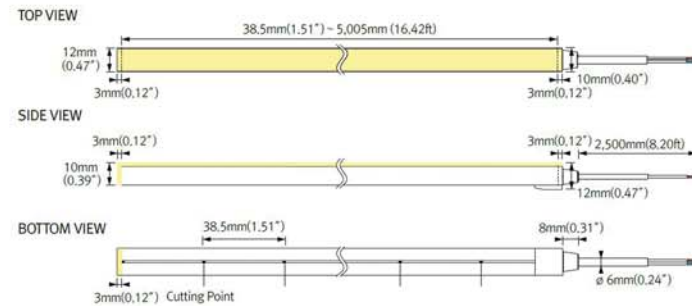

| TYPE  | CRI   | LIGHT OUT | POWER | COLOR TEMP |
|-------|-------|-----------|-------|------------|
| 91100 | 80 Ra | 199 lm    | 3,8 W | 2200K      |
| 91110 | 80 Ra | 214 lm    | 3,8 W | 2700K      |
| 91120 | 80 Ra | 216 lm    | 3,8 W | 3000K      |
| 91130 | 80 Ra | 255 lm    | 3,8 W | 3500K      |
| 91140 | 80 Ra | 255 lm    | 3,8 W | 4000K      |

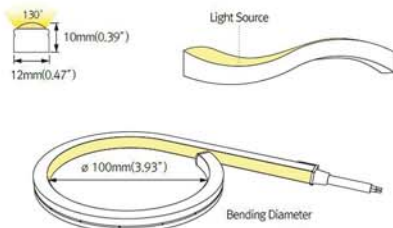

## DESCRIPTION

Direct or indirect lighting  
1-10V Dimming.  
IP class: IP20/IP67  
Length 5000mm,  
max. length 10meter

Certificates: CE

Color: White

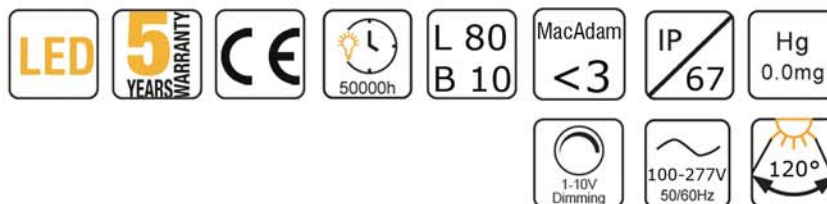
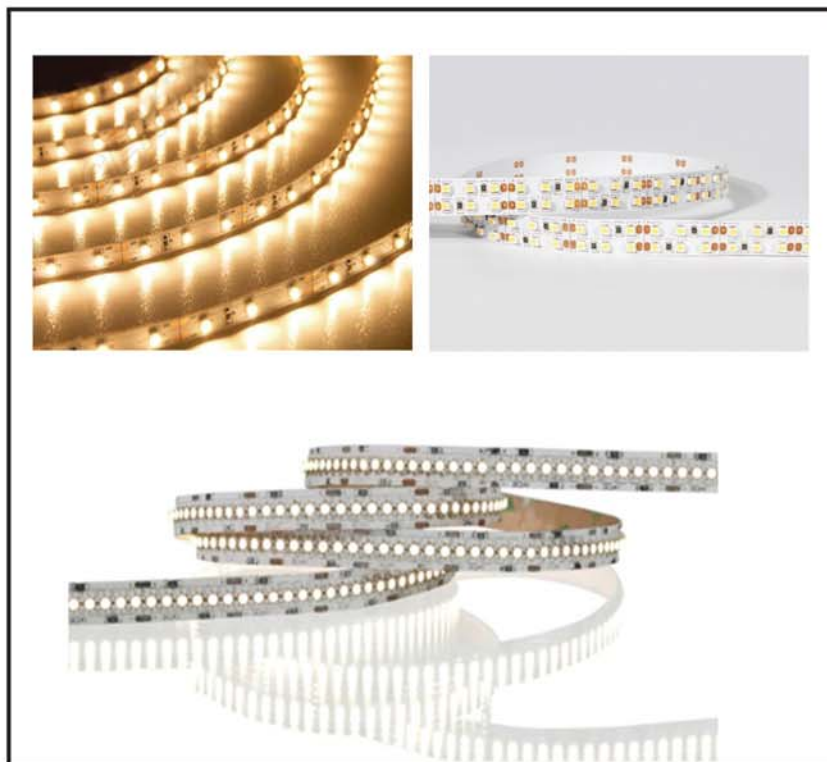

## AREA OF USE

Ceiling, wall, signs, furniture etc.

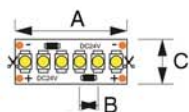

## CAN BE DELIVERED WITH:

2700K/3000K/4000K/5000K

|       | A  | B   | C  | D |
|-------|----|-----|----|---|
| 91200 | 50 | 8.3 | 8  | 2 |
| 91210 | 25 | 4.2 | 10 | 2 |
| 91220 | 50 | 8.3 | 15 | 2 |
| 91230 | 25 | 4.2 | 10 | 2 |

| TYPE  | CRI    | LIGHT OUT | POWER | KELVIN     |
|-------|--------|-----------|-------|------------|
| 91200 | >80 Ra | 670 lm    | 9,6W  | 2700-4000K |
| 91210 | >80 Ra | 1080 lm   | 14,4W | 2700-5000K |
| 91220 | >80 Ra | 1600 lm   | 19,2W | 2700-5000K |
| 91230 | >80 Ra | 1600 lm   | 19,2W | 2700-5000K |

# LED profiles AR

## DESCRIPTION

Surface or profile mounted  
Direct or indirect lighting  
It is recommended to mount LED strips on smooth, clean surfaces or with associated mounting clips.

Certificates: CE/TUV/GS

Color: Alu

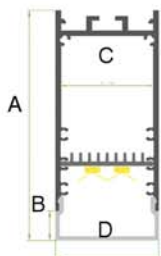
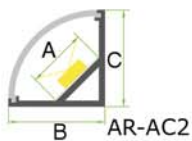
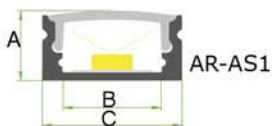
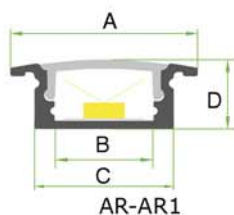

## AREA OF USE

Hotel, office, healthcare, shops and other public places

|       | A   | B  | C  | D   |
|-------|-----|----|----|-----|
| 91240 | 78  | 10 | 31 | 35  |
| 91241 | 23  | 12 | 17 | 8.5 |
| 91242 | 8.6 | 12 | 17 | -   |
| 91243 | 10  | 16 | 16 | -   |

| TYPE  | MAX. POWER | LENGTH |
|-------|------------|--------|
| 91240 | 19w        | 2500mm |
| 91241 | 19W        | 2500mm |
| 91242 | 19W        | 2500mm |
| 91243 | 38W        | 2500mm |



# Goal

## DESCRIPTION

Aluminum body with rotating top bar.  
Ideal for showcase or exhibition

Easy assembly.

Various length available

Housing made of die cast aluminium.

The top bar can rotate 90°/180°/270°

Luminous efficacy: 80lm/W

Certificates: CE/UL

Colors: Black



LED SLIM TRACKS/  
CABINET LIGHTING

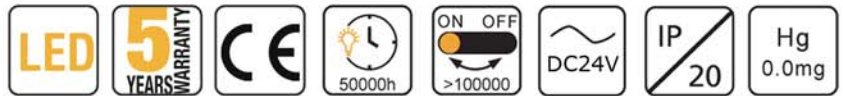

## PHOTOMETRIC CURVE

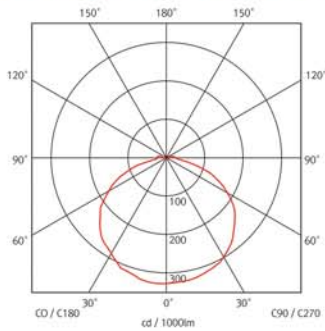

|   | A    | B    |
|---|------|------|
| x | 397  | 381  |
| x | 677  | 661  |
| x | 956  | 940  |
| x | 1235 | 1219 |

## AREA OF USE

Displays, jewelry, art lighting

## CAN BE DELIVERED WITH

2700K/3000K/3500K/4000K/6000K

| TYPE | CRI    | LIGHT OUT | POWER | COLOR TEMP |
|------|--------|-----------|-------|------------|
| x    | >90 Ra | 290 lm    | 3 W   | 3000K      |
| x    | >90 Ra | 570 lm    | 7 W   | 3000K      |
| x    | >90 Ra | 860 lm    | 11 W  | 3000K      |
| x    | >90 Ra | 1200 lm   | 15 W  | 3000K      |

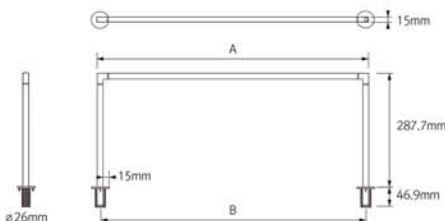

# Diamond Kit

LED SLIM TRACKS/  
CABINET LIGHTING

## DESCRIPTION

The showcase kit convenient for all. Plug & Play display system.

Adjustable pole length

Slide LED fixtures along power track

To be used with constant voltage DC 24V driver

Housing made of die cast aluminium.

Easy installation and operation

Certificates: CE/UL

Beam angle  
Spot: 15°/30°  
Spot HO: 25°/45°/60°

Colors: Silver or black

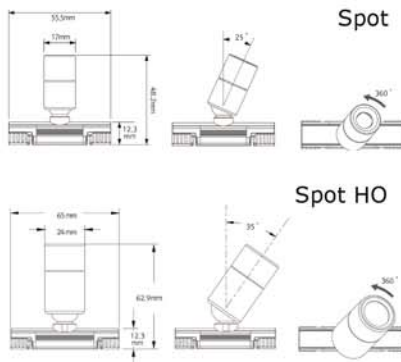
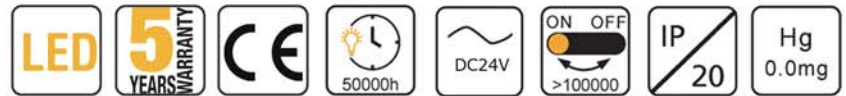

## AREA OF USE

Displays, jewelry, art or shop lighting

## CAN BE DELIVERED WITH

Spot HO can be delivered in white

## Power supply cable to the pole

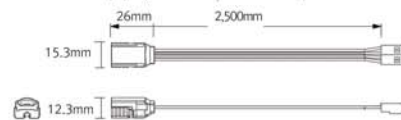

## Extrusion pole

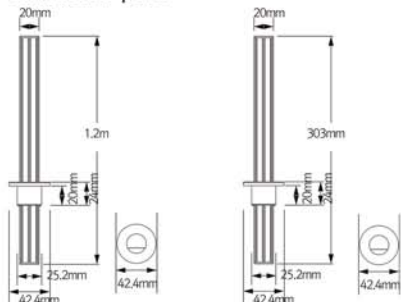

| TYPE | Description  | POWER                |
|------|--|----------------------|
| x    | Spot   | 1 W                  |
| x    | Spot HO  | 3 W                  |
| x    | Extrusion pole                                     | length 300 or 1200mm |
| x    | Power supply cable to the pole                     |                      |
| x    | LED Driver with 12way distributor, with power cord |                      |
| x    | LED Driver: 200W, 24V                              |                      |

## DESCRIPTION

Mini spotlight with various beam angle.

Dimmable with available accessories.

To be used with constant voltage DC 24V driver.

Color Rendering Index : >90

Luminous efficacy: 98Lm/W

Housing made of die cast aluminium.

Spot head can adjust 90°, Rotate 360°

Certificates: CE/UL

Beam angle 28°/40°/50°

Colors: White, black, silver or gold



## PHOTOMETRIC CURVE

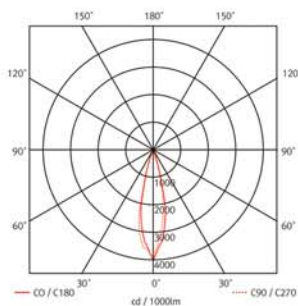

|       | A  | B  | C  | D  | E  |
|-------|----|----|----|----|----|
| 92100 | 87 | 59 | 62 | 50 | 62 |

## AREA OF USE

Display windows, shops, corridor, bedroom

## CAN BE DELIVERED WITH

2700K/3000K/3500K/4000K

Round or square surface plate

Dimming : On-Off/0-10V/DALI/Zigbee

| TYPE  | CRI   | LIGHT OUT | POWER | COLOR TEMP |
|-------|-------|-----------|-------|------------|
| 92100 | 90 Ra | 253 lm    | 2,6 W | 3000K      |

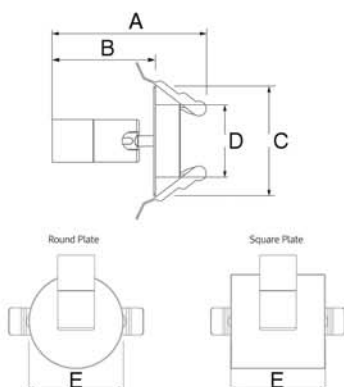





**T5 Tube**  
Lumen output  
Max. 4.800 Lm

Page 165



**T8 Tube**  
**175 Lm/W**

Lumen output  
Max. 5.250 Lm

Page 167



**T5 Tube**  
**200 Watt Change**  
Lumen output  
Max. 4800 Lm

Page 166



**T8 Tube**  
**200 Lm/W**

Lumen output  
Max. 4.800 Lm

Page 168

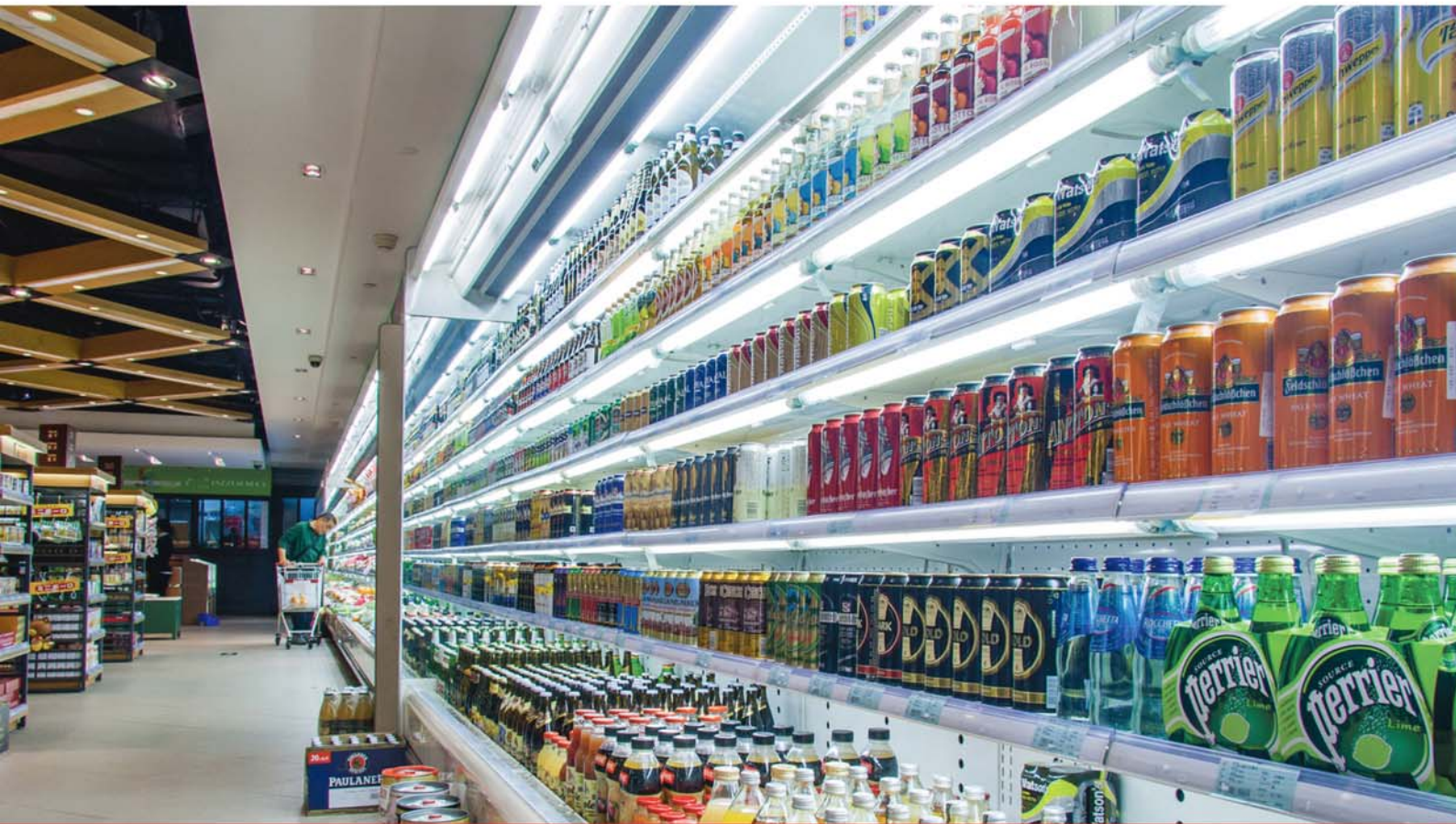

# T5 Tube

## DESCRIPTION

Professional LED T5 led tube to replace T5 fluorescent.

Fit for any T5 fixture and easy installation.

Energy saving and high color index.

Flicker free.

Housing Material:  
Aluminum + PC

Socket: G5

Certificates: CE/TUV/GS

Color: White

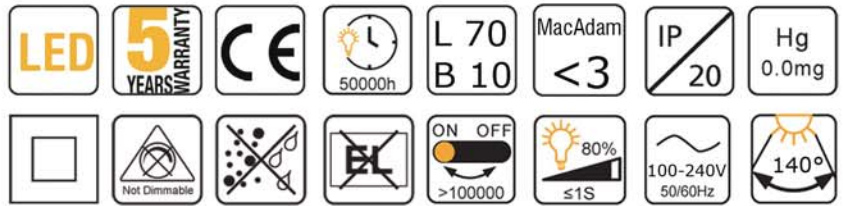

## AREA OF USE

Hotel, meeting room, office, school, hospital to replace traditional incandescent lamps.

|       | A    | B  |
|-------|------|----|
| 60cm  | 562  | 22 |
| 90cm  | 862  | 22 |
| 120cm | 1162 | 22 |
| 150cm | 1462 | 22 |

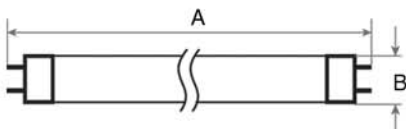

| TYPE  | CRI    | LIGHT OUT | POWER | KELVIN | NOTE   |
|-------|--------|-----------|-------|--------|--------|
| 01200 | >80 Ra | 1350 lm   | 9 W   | 3000K  | 60 cm  |
| 01210 | >80 Ra | 1440 lm   | 9 W   | 4000K  | 60 cm  |
| 01220 | >80 Ra | 1800 lm   | 12 W  | 3000K  | 90 cm  |
| 01230 | >80 Ra | 2400 lm   | 15 W  | 4000K  | 90 cm  |
| 01240 | >80 Ra | 3200 lm   | 20 W  | 3000K  | 120 cm |
| 01250 | >80 Ra | 3200 lm   | 20 W  | 4000K  | 120 cm |
| 01260 | >80 Ra | 4000 lm   | 25 W  | 4000K  | 120 cm |
| 01270 | >80 Ra | 3200 lm   | 20 W  | 3000K  | 150 cm |
| 01280 | >80 Ra | 4000 lm   | 25 W  | 4000K  | 150 cm |
| 01290 | >80 Ra | 4800 lm   | 30 W  | 3000K  | 150 cm |







## DESCRIPTION

Energy saving and high color index.  
Light efficiency 175Lm/W

Safer and more reliable, leading technology  
Greener and more energy saving, durable structure  
Higher efficacy to save much more energy  
LED Chip: SMD2835  
Driver: Internal Driver  
PC cover: Frosted & Clear optional  
End Cap: Rotatable available.  
Single & double end input optional  
Flicker Free optional.  
A6063 aluminum material with excellent heat dissipation, not easy to deform.  
19mm Width PCB ensures longer lifespan and safety.  
G13 fixed or rotatable end cap is available

Certificates: TUV-VE, CE, SAA, RoHS, LM79, LM80

Color: White

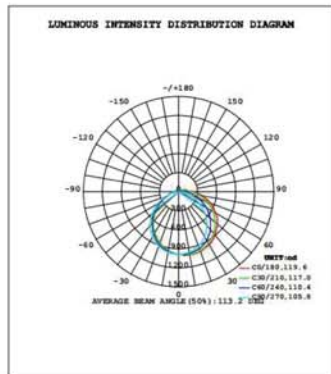
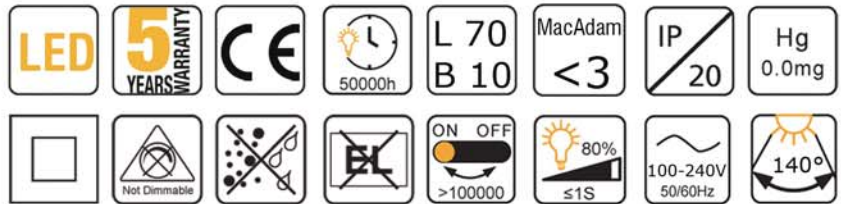
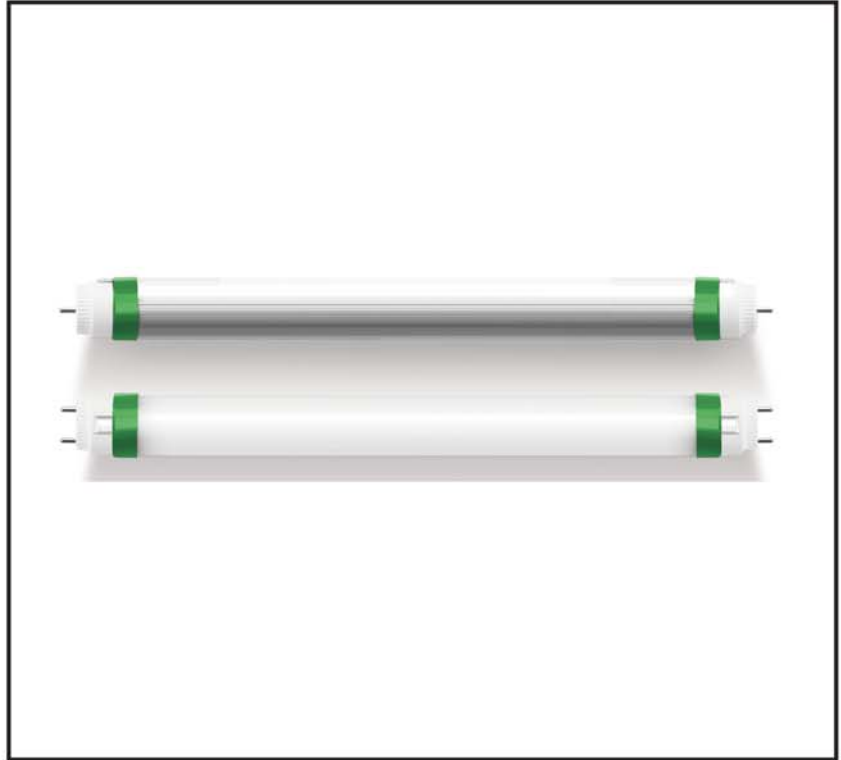

## AREA OF USE

Hotel, meeting room, office, school, hospital, supermarked, parking area and to replace traditional incandescent lamps.

## CAN BE DELIVERED WITH

3000/4000/5000/5700/6000/6500K

|       | A    | B    |
|-------|------|------|
| 60cm  | 602  | 588  |
| 90cm  | 906  | 892  |
| 120cm | 1212 | 1198 |
| 150cm | 1512 | 1498 |

| TYPE  | CRI    | LIGHT OUT | POWER | KELVIN | NOTE   |
|-------|--------|-----------|-------|--------|--------|
| 01703 | >80 Ra | 1575lm    | 9 W   | 3000K  | 60 cm  |
| 01713 | >80 Ra | 2100lm    | 12 W  | 3000K  | 90 cm  |
| 01723 | >80 Ra | 2100lm    | 12 W  | 3000K  | 120 cm |
| 01733 | >80 Ra | 3150lm    | 18 W  | 3000K  | 120 cm |
| 01743 | >80 Ra | 3500lm    | 20 W  | 3000K  | 120 cm |
| 01753 | >80 Ra | 4375lm    | 25 W  | 3000K  | 150 cm |
| 01763 | >80 Ra | 5250lm    | 30 W  | 3000K  | 150 cm |

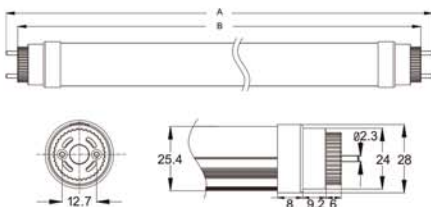

## DESCRIPTION

Energy saving and high color index.  
Light efficiency 200Lm/W

Safer and more reliable,  
leading technology  
Greener and more energy saving,  
durable structure  
Higher efficacy to save much more energy  
Longer Lifespan for very less heat  
A6063 aluminum material with excellent heat dissipation, not easy to deform.  
Special coating to avoid aluminum exposure  
Beam angle: Clear cover 120°  
Frosted cover 140°

Socket: G8

Certificates: CE/TUV/SAA/RoHS/Lm79

Color: White

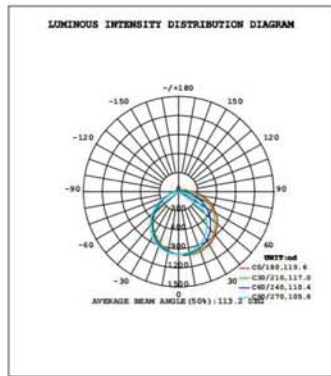
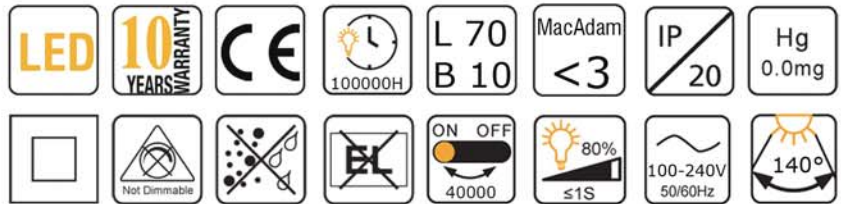

## AREA OF USE

Hotel, meeting room, office, school, hospital, supermarked, parking area and to replace traditional incandescent lamps.

## CAN BE DELIVERED WITH

3000/4000/5000/5700/6000/6500K

|       | A    | B    |
|-------|------|------|
| 60cm  | 603  | 588  |
| 90cm  | 907  | 892  |
| 105cm | 1061 | 1047 |
| 120cm | 1213 | 1198 |
| 150cm | 1513 | 1498 |

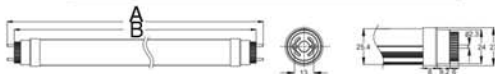

| TYPE  | CRI    | LIGHT OUT   | POWER   | KELVIN | NOTE   |
|-------|--------|-------------|---------|--------|--------|
| 01503 | >80 Ra | 1200/1800lm | 6/9 W   | 3000K  | 60 cm  |
| 01513 | >80 Ra | 1200/1800lm | 9/12 W  | 3000K  | 90 cm  |
| 01523 | >80 Ra | 2000/3000lm | 10/15 W | 3000K  | 105 cm |
| 01533 | >80 Ra | 2000/3000lm | 10/15 W | 3000K  | 120 cm |
| 01543 | >80 Ra | 2400/3600lm | 12/18 W | 3000K  | 120 cm |
| 01553 | >80 Ra | 3200/4800lm | 16/24 W | 3000K  | 150 cm |
| 01563 | >80 Ra | 3200/4800lm | 20/24 W | 3000K  | 150 cm |





**Logo Tracklight**

Page 170



**Logo Downlight**

Page 171

LED LOGO LIGHT





## DESCRIPTION

Lighting for marketing is a very effective eye-catcher. Logo lamps project an image, logo or whatever you want on a given surface.

The logo/the gobo is placed in the lamp and the optics are sharpened. This spot has engines that allow the logo to run, rotate and change color. Remote control  
Suitable for own gobos.

Certificates: CE

Colors: Black



|            |                         |           |        |            |                   |          |                     |
|------------|-------------------------|-----------|--------|------------|-------------------|----------|---------------------|
| <b>LED</b> | <b>5 YEARS WARRANTY</b> | <b>CE</b> | 50000h | 80%<br>≤1S | ON OFF<br>>100000 | IP<br>20 | Hg<br>0.0mg         |
|            |                         |           |        |            |                   |          | 220-240V<br>50/60Hz |

## AREA OF USE

Office, healthcare, hotel, shops and other public places

|       | A   | B   |
|-------|-----|-----|
| 01401 | 195 | 202 |

| TYPE  | POWER |
|-------|-------|
| 01401 | 10 W  |

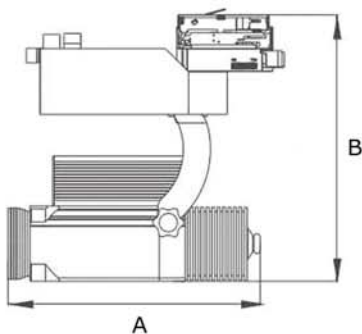

## DESCRIPTION

Lighting for marketing is a very effective eye-catcher. Logo lamps project an image, logo or whatever you want on a given surface. The logo/the gobo is placed in the lamp and the optics are sharpened. Suitable for own gobos.

Certificates: CE

Colors: Black



|     |                  |    |        |                |             |       |                  |
|-----|------------------|----|--------|----------------|-------------|-------|------------------|
| LED | 5 YEARS WARRANTY | CE | 50000h | ON OFF >100000 | 90mm Cutout | IP 20 | Hg 0.0mg         |
|     |                  |    |        |                |             |       | 220-240V 50/60Hz |

## AREA OF USE

Office, healthcare, hotel, shops and other public places

|       | A   | B   | C   |
|-------|-----|-----|-----|
| 01402 | 195 | 155 | 100 |

| TYPE  | POWER |
|-------|-------|
| 01402 | 10 W  |

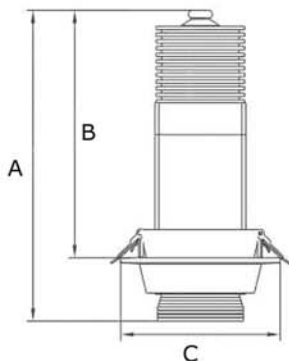







# Pictograph Description



**Ingress Protection**



**No mercury**



**Median lifetime**



**MacAdam color steps** is a term associated with LEDs that indicates the tolerance level where the human eye cannot perceive fluctuation



**Tested for 1000.000 turn on/off**



**For indoor use only**



**Dimmable**



**Double insulated. Does not need to be grounded.**



The **CE marking** is an indicator of a product's compliance with EU legislation



**Range of lighting**



**UGR = Unified Glare Rating**



**Rotate range**



**Warm up time is less than 1 second**



**Swivel range**



**Voltage**



**Can be used for emergency**



**Needs to be grounded**



**Sensor**



**IK CODE**  
**Protection against mechanical impacts**



**Not dimmable**



**Size of cutout**



**Luminaires are declared as L70, L80 or L90. L-values are combined with a calculated time. The L-value indicates how many lumens (in percentage related to the initial lumens) there are at the declared time. The B-value describes the failure fraction.**



**Uses LED**



**Five years warranty**