



Verona Round Light Direct

Lumen output
Max. 20000 Lm

Page 87



Calypso Pendant

Lumen output
Max. 5000Lm

Page 94



Verona Round Light Up/Down

Lumen output
Max. 20000 Lm

Page 88



Calypso Mini Pendant

Lumen output
Max. 1900Lm

Page 96



Moon

Lumen output
Max. 12000 Lm

Page 89



DSG Pendant

Lumen output
Max. 1520Lm

Page 97



Palermo

Lumen output
Max. 14400 Lm

Page 91



Halo Ring

Lumen output
Max. 4500 Lm

Page 92





DESCRIPTION

The round Verona luminaire is optimised to meet the demands of contemporary offices, conference rooms of all kinds, as well as other applications. Covered with the cord pendant, rod pendant, ceiling, recessed and wall-mounted luminaires incorporate a homogeneous light surface. The elegant Verona fitting thereby complements interior architecture and simultaneously creates a pleasant working atmosphere. Verona generates extremely homogeneous, glare-free, powerful and yet soft light.

Certificates: CE/ETL/CCC

Beam angle 90° or 120°

Colors: White/black/silver



LED	5 YEARS WARRANTY	CE	50000h	L 70 B 50	MacAdam 3	IP 20	Hg 0.0mg
UGR <19	ON OFF >100000	80% ≤1S	90-277V 50/60Hz				

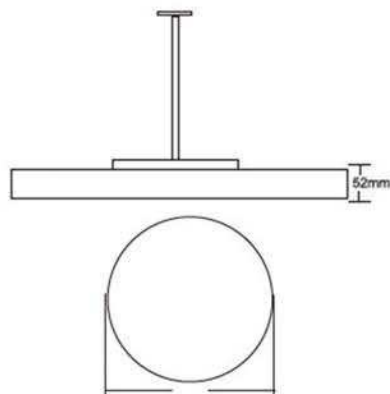
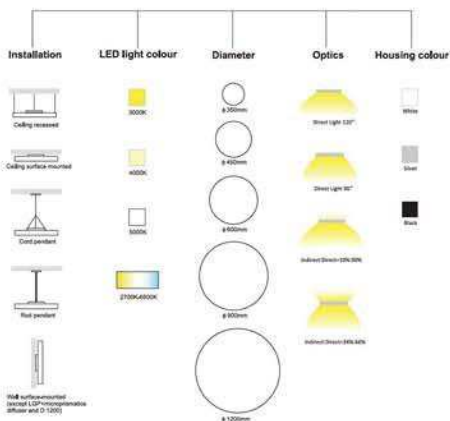

D350mm / D450mm / D600mm / D900mm / D1200mm

AREA OF USE

Office, Education, Healthcare, Public

CAN BE DELIVERED WITH:

2700K - 6500K

TYPE	CRI	LIGHT OUT	POWER	COLOR TEMP
40000	80 Ra	2000 lm	15 W	2700-6500K
40010	80 Ra	2400 lm	18 W	2700-6500K
40020	80 Ra	4000 lm	23 W	2700-6500K
40030	80 Ra	5000 lm	31 W	2700-6500K
40040	80 Ra	6000 lm	46 W	2700-6500K
40050	80 Ra	8000 lm	62 W	2700-6500K
40060	80 Ra	12000 lm	92 W	2700-6500K
40070	80 Ra	16000 lm	123 W	2700-6500K
40080	80 Ra	16000 lm	123 W	2700-6500K
40090	80 Ra	20000 lm	152 W	2700-6500K

DESCRIPTION

The round Verona luminaire is optimised to meet the demands of contemporary offices, conference rooms of all kinds, as well as other applications. Covered with the cord pendant, rod pendant, ceiling, recessed and wall-mounted luminaires incorporate a homogeneous light surface. The elegant Verona fitting thereby complements interior architecture and simultaneously creates a pleasant working atmosphere. Verona generates extremely homogeneous, glare-free, powerful and yet soft light.

Certificates: CE/ETL/CCC

Beam angle 90° or 120°

Colors: White/black/silver



LED	5 YEARS WARRANTY	CE	50000h	L 70 B 50	MacAdam 3	IP 20	Hg 0.0mg
UGR <19	ON OFF >100000	80% ≤1S	90-277V 50/60Hz				

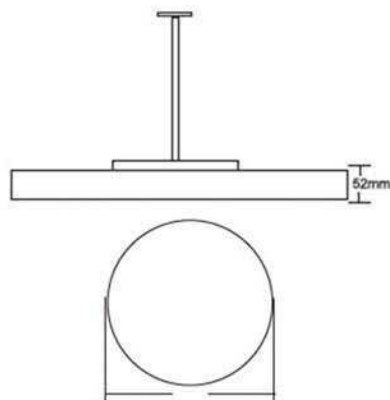
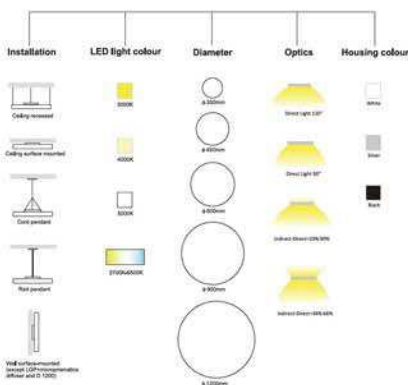

D350mm / D450mm / D600mm / D900mm / D1200mm

AREA OF USE

Office, education, healthcare, public etc.

CAN BE DELIVERED WITH:

2700K - 6500K

TYPE	CRI	LIGHT OUT	POWER	COLOR TEMP
40100	80 Ra	260+2400 lm	20 W	2700-6500K
40110	80 Ra	1200+2400 lm	27 W	2700-6500K
40120	80 Ra	445+4000 lm	34 W	2700-6500K
40130	80 Ra	2000+4000 lm	48 W	2700-6500K
40140	80 Ra	888+8000 lm	68 W	2700-6500K
40150	80 Ra	4000+8000 lm	91 W	2700-6500K
40160	80 Ra	1777+16000 lm	136 W	2700-6500K
40170	80 Ra	8000+16000 lm	184 W	2700-6500K
40180	80 Ra	2222+20000 lm	171 W	2700-6500K
40190	80 Ra	10000+20000 lm	231 W	2700-6500K

DESCRIPTION

This product adopts simple and clean concept. Low UGR help offer the most comfortable lighting environment, Up and down light could help make the lighting environment look more spacious. The products advantage: uniform luminescence, no spots. Standard delivery: Switch for Direct or Indirect Light + Switch for 3000 or 4000 K. Dali Driver and Microprisma- tisc diffuser UGR <19.

Installation: surfaced , wall , suspended cable and suspended rod. Luminous Efficacy: up to 120 Lm/W

Certificates: CE/RoHS
Beam angle 110°

Colors: White/black



LED	5 YEARS WARRANTY	CE	50000h	L 90	MacAdam >3	IP 20	Hg 0.0mg
					URG <19	100-277V/ 200-240V	110°



AREA OF USE

Lobby, office, hotel other public places

CAN BE DELIVERED WITH:

2700K-6500K
Non DIM/DIM 1-10V/ DIM TRAIC/ Casambi

	A	B	C
40700	Ø435	115	80/90
40710	Ø585	115	80/90
40720	Ø735	115	80/90
40730	Ø875	115	80/90
40740	Ø1150	115	80/90

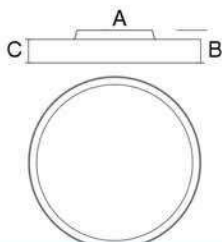

TYPE	CRI	LIGHT OUT	POWER	COLOR TEMP
40700	>80 Ra	4400 Lm	40 W	3000/4000K
40710	>80 Ra	6600 Lm	60 W	3000/4000K
40720	>80 Ra	7000 Lm	70 W	3000/4000K
40730	>80 Ra	9000 Lm	90 W	3000/4000K
40740	>80 Ra	12000 Lm	120 W	3000/4000K
40750	Suspension Kit Wire 1500mm			
40760	Suspension Kit Rod mounted 1500mm (450/600/750/900)			
40770	Suspension Kit Rod mounted 1500mm (1200) 3 pcs.			



DESCRIPTION

LED Round luminaire Surfaced mounted/Pendant Microprismatic diffuser

Material: aluminium

Available in Different sizes

from Ø435mm up to

Ø1150mm

Dimmable/DALI

Beam Angle: 120°

Certificates: CE

Color: White/black/silver

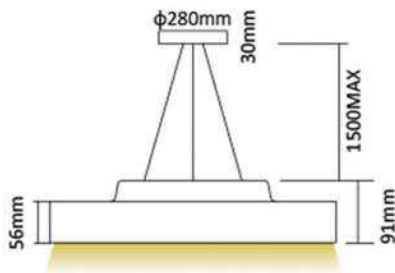
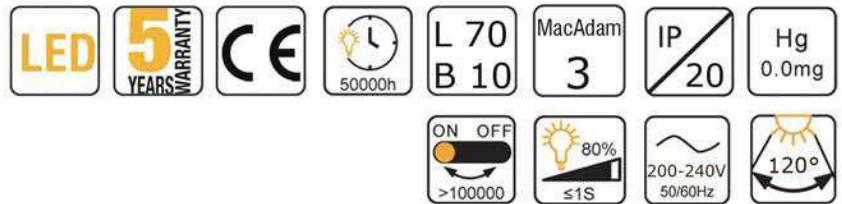

Direct light

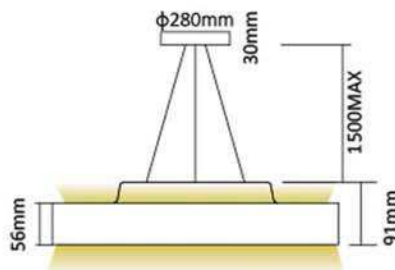

Direct and indirect lighting

AREA OF USE

Hotel, meeting room, office, school, etc.

CAN BE DELIVERED WITH:

2700K-6500K

TYPE	CRI	LIGHT OUT	POWER	KELVIN	DIMENSION
40500	>80 Ra	3600 lm	30 W	3000K	Ø435*86mm
40510	>80 Ra	4800 lm	40 W	3000K	Ø435*86mm
40520	>80 Ra	4800 lm	40 W	3000K	Ø585*86mm
40530	>80 Ra	7200 lm	60 W	3000K	Ø585*86mm
40540	>80 Ra	6000 lm	50 W	3000K	Ø735*86mm
40550	>80 Ra	8400 lm	70 W	3000K	Ø735*86mm
40560	>80 Ra	8400 lm	70 W	3000K	Ø875*86mm
40570	>80 Ra	10800 lm	90 W	3000K	Ø875*86mm
40580	>80 Ra	10800 lm	90 W	3000K	Ø1150*86mm
40590	>80 Ra	14400 lm	120 W	3000K	Ø1150*86mm

Halo Ring

LED PENDANT

DESCRIPTION

This product adopts simple and clean concept.
 Mounting: Suspending, Ceiling surface, Recessed mounting
 No dark area, lighting uniformly, excellent heat dissipation performance

Luminous efficacy: 110Lm/W
 Color Rendering Index: Ra>80 or Ra>90(upgrade)

ENEC, UL certified driver, flicker free, driver build-in, power factor >0.9

Material: 1.5mm thick extrusion aluminum profile housing, frosted PC cover

Diameter available in: 0.45m, 0.6m, 0.78m, 0.9m, 1.0m, 1.2m, 1.5m, 2.0m, 2.4m, 3.0m, 4.0m, 5.0m

Certificates: CE/RoHS

Colors: White or black. Silver or golden is optional to upgrade

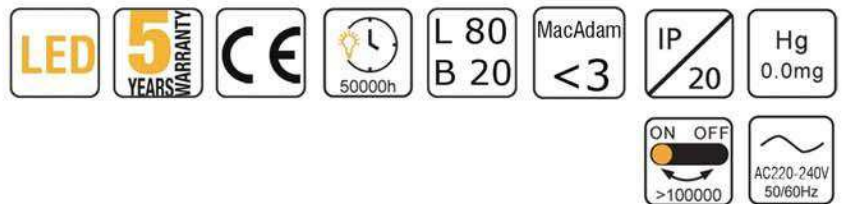

AREA OF USE

Office, Mall, Station, Shops, Restaurant, Bank and other public places

CAN BE DELIVERED WITH:

3000K/4000K/6000K
 Dimming: DALI/Casambi/Master Connect

TYPE	CRI	LIGHT OUT	POWER	DIMENSION
80100	>80 Ra	2000 lm	20 W	Ø450mm
80101	>80 Ra	3000 lm	30 W	Ø600mm
80102	>80 Ra	4000 lm	40 W	Ø900mm
80103	>80 Ra	5000 lm	50 W	Ø1000mm
80104	>80 Ra	6000 lm	60 W	Ø1200mm
80105	>80 Ra	8000 lm	80 W	Ø1560mm
80106	>80 Ra	11000 lm	110 W	Ø1860mm
80107	>80 Ra	12000 lm	120 W	Ø2060mm
80108	>80 Ra	15000 lm	150 W	Ø2460mm
80109	>80 Ra	18000 lm	180 W	Ø3060mm
80110	>80 Ra	24000 lm	240 W	Ø4060mm
80111	>80 Ra	32000 lm	320 W	Ø5060mm



DESCRIPTION

Surface mounted ceiling light.

Housing made out of die cast aluminium.

Easy to install

High purity aluminium reflector consist of 99,9% aluminium. Philips SLM G7 slim system allow to produce fixture of homogenous lighting performance and high-efficiency natural looking light.

Certificates: CE/ETL/CCC

Beam angle 12°/24°/36°/50°

Colors: White/black/silver



PHOTOMETRIC CURVE

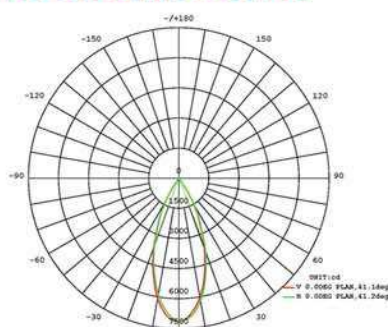

	A	B
40400	258mm	Ø125mm

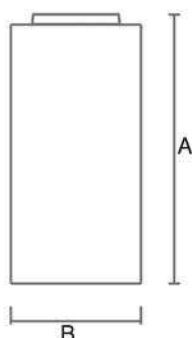

AREA OF USE

Bedroom, living room, corridor, shops, office, hotel, restaurant

CAN BE DELIVERED WITH:

- 4000K
- Food COB
- Meat COB

TYPE	CRI	LIGHT OUT	POWER	COLOR TEMP
40400	>80 Ra	3000 lm	21 W	3000K
40400	>80 Ra	3500 lm	25 W	3000K
40400	>80 Ra	4000 lm	27 W	3000K
40400	>80 Ra	4500 lm	31 W	3000K
40400	>80 Ra	5000 lm	35 W	3000K
40400	>90 Ra	3000 lm	26 W	3000K
40400	>90 Ra	3500 lm	32 W	3000K
40400	>90 Ra	4000 lm	33 W	3000K
40400	>90 Ra	4500 lm	38 W	3000K
40400	>90 Ra	5000 lm	43 W	3000K



Calypso Mini Pendant

DESCRIPTION

Suspended pendant
Easy to install

Aluminium profile provides excellent thermal dissipation. Isolated driver solution both in dimmable and non-dimmable version achieves stable working performance.

Certificates: CE/SAA/RoHS

Colors: White/black



LED PENDANT



PHOTOMETRIC CURVE

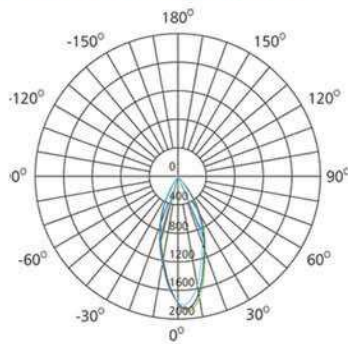

	A	B
40300/10	Ø80	130
40320/30	Ø80	160
40340/50	Ø113	160

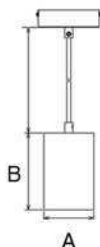

AREA OF USE

Bedroom, living room, corridor, shops, office, hotel, restaurant etc.

CAN BE DELIVERED WITH

2700K/3000K/4000K/5000K

TYPE	CRI	LIGHT OUT	POWER	COLOR TEMP
40300	>80 Ra	850 lm	10 W	2700K
40310	>80 Ra	860 lm	10 W	3000K
40320	>80 Ra	1400 lm	18 W	2700K
40330	>80 Ra	1450 lm	18 W	3000K
40340	>80 Ra	1880 lm	25 W	2700K
40350	>80 Ra	1970 lm	25 W	3000K

DESCRIPTION

Industrial and simple design
 Surface mounted ceiling lamp
 Easy to install
 Material body: metal
 Glass plate
 Ceiling plate: metal
 Black cabel wire: 1,2m
 Light source E27 max. 60W

Certificates: CE

Color: Black

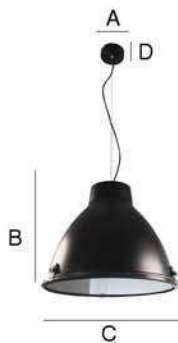
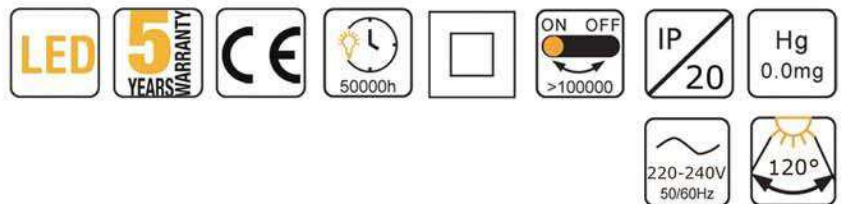

AREA OF USE

Hotel, meeting room, office, school, living room, corridor, shops, restaurant etc.

	A	B	C	D
40600	10	565	430	2

TYPE	CRI	LIGHT OUT	POWER	KELVIN
40600	80 Ra	1521 lm	13,5 W	2700K



Everline
Lumen output
Max. 10.000 Lm

Page 99

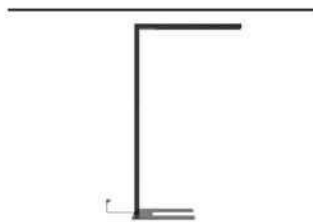

Rho
Lumen output
Max. 9000 Lm

Page 107

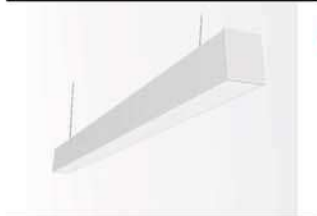

Asti
Lumen output
Max. 12.000 Lm

Page 101



Caivano
Lumen output
Max. 4000 Lm

Page 102



Capri
Lumen output
Max. 12.000 Lm

Page 104



DESCRIPTION

High light efficiency of more than 140lm/W
 Optimal glare control, UGR<19
 Seamless connection and no light leakage
 Uniform illumination, direct and indirect light
 Standalone type and continuous row optional
 compact profile with refined surface finish
 Can be flexibly connected to myriad of shapes
 Comply with EN12464-1 standart
 Easy installation without tool needed
 No flickering, visual comfort
 Can be delivered with motion sensor.

Continuous Luminaire

Certificates: CE/ETL/CCC

Colors: White/black/silver



AREA OF USE

Office, education, healthcare, public

CAN BE DELIVERED WITH:

3000K/4000K/5000K

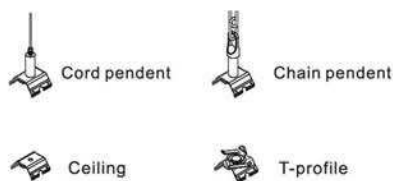

	A	B	C
72100-20	1200	65	86
72130-50	1500	65	86
72160-80	3000	65	86

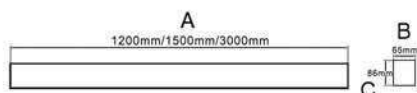

TYPE	CRI	LIGHT OUT	POWER	COLOR TEMP
72100	>80 Ra	2400 lm	17 W	3000K
72110	>80 Ra	3000 lm	22 W	3000K
72120	>80 Ra	4000 lm	29 W	3000K
72130	>80 Ra	3000 lm	22 W	3000K
72140	>80 Ra	4000 lm	29 W	3000K
72150	>80 Ra	5000 lm	36 W	3000K
72160	>80 Ra	6000 lm	43 W	3000K
72170	>80 Ra	8000 lm	57 W	3000K
72180	>80 Ra	10000 lm	72 W	3000K

Pendant

Ceiling-mounted

Recessed



DESCRIPTION

Professional linear lights for Office and Public Area

Luminous efficacy: 140Lm/W

Mounting:
Recessed/Pendant/Surface-mounted.

Individual or continuous configuration. Fast installation and easy maintenance.

Seamless connection without light leakage.
Dot free illumination and screwless end cap.

Shining free and uniform light

Certificates: CE/ETL/CCC

Beam angle: 80°direct/
140°indirect

Colors: White/black

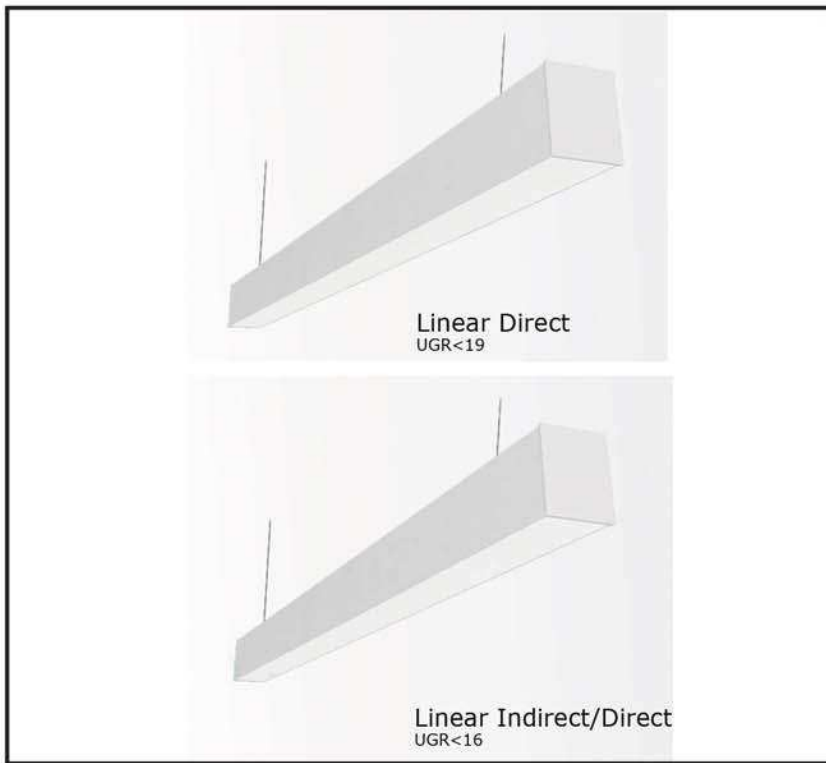

PHOTOMETRIC CURVE

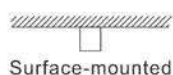
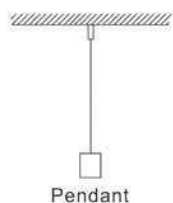
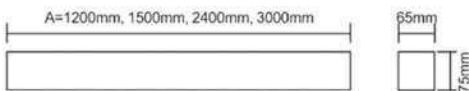
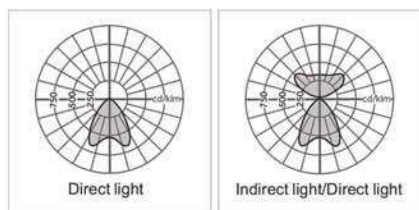

AREA OF USE

Office, Education, Communication area and Public Area

CAN BE DELIVERED WITH:

Optics: Direct or Indirect/Direct
Control: On-Off/DALI/Push Dimming/CCT Turnable/
Casambi/Human Centric Lighting/Sensor/Emergency
CCT: 3000K/3500K/4000K/3000-6500K

TYPE	CRI	LIGHT OUT	POWER	COLOR TEMP
50000	>80 Ra	3200 lm	25 W	Direct
50010	>80 Ra	4000 lm	31 W	Direct
50020	>80 Ra	6400 lm	50 W	Direct
50030	>80 Ra	8000 lm	62 W	Direct
50100	>80 Ra	4800 lm	37 W	Indirect/Direct
50110	>80 Ra	6000 lm	46 W	Indirect/Direct
50120	>80 Ra	9600 lm	74 W	Indirect/Direct
50130	>80 Ra	12000 lm	92 W	Indirect/Direct

DESCRIPTION

DB45 is a module changeable design LED batten, provide good heat dissipation, quality light and substantial energy and maintenance savings. Suspended, surface mounted and splicing installation optional. The process of installing and maintaining is so easy.

Module changeable, with easy installation and maintenance
Module type optional (type A reflector design, Type B diffuser design)

Color temperature switchable by DIP switch

Splicing design

Non-DIM

Certificates: CE

Beam angle 100°

Colors: White/black

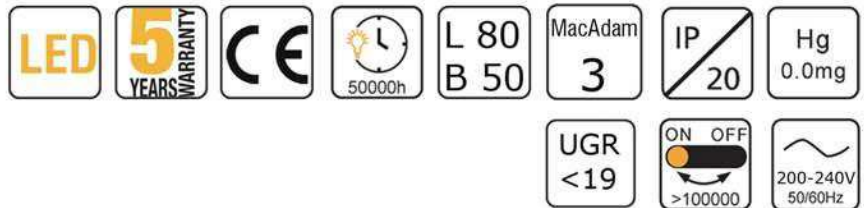

AREA OF USE

For traditional suspended installation such as workshop, utility rooms, garages and more.

CAN BE DELIVERED WITH:

3-CCT: 3000/4000/5700K

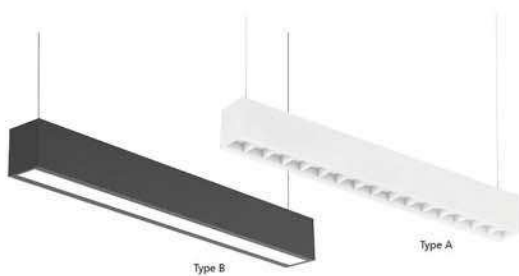

	A	B	C
50420/30	1204	60	70

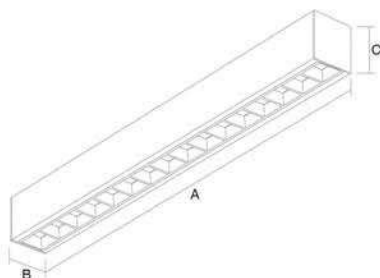

TYPE	CRI	LIGHT OUT	POWER	COLOR TEMP
50420	80 Ra	4800 lm	40 W	3/4/5700K
50430	80 Ra	4000 lm	40 W	3/4/5700K



DESCRIPTION

Professional linear lights for Office and Public Area

Luminous efficacy: 135 lm/W

Mounting:
Recessed/Pendant/Surface-mounted.

Individual or continuous configuration. Fast installation and easy maintenance.

Seamless connection without light leakage.
Dot free illumination and screwless end cap.

Shining free and uniform light

Certificates: CE/ETL/CCC

Beam angle: 70°direct/
140°indirect

Colors: White/black



PHOTOMETRIC CURVE

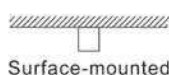
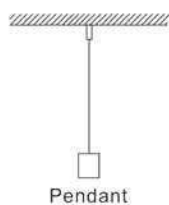
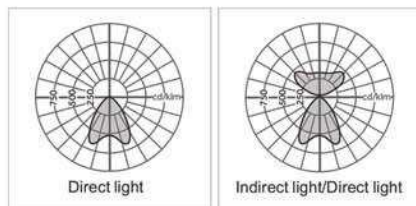

AREA OF USE

Office, Education, Communication area and Public Area

CAN BE DELIVERED WITH:

Optics: Direct or Indirect/Direct
Control: On-Off/DALI/Push Dimming/CCT Turnable/
Casambi/Human Centric Lighting/Sensor/Emergency
CCT: 3000K/3500K/4000K/3000-6500K

TYPE	CRI	LIGHT OUT	POWER	COLOR TEMP
50700	>80 Ra	3200 lm	25 W	Direct
50701	>80 Ra	4000 lm	32 W	Direct
50702	>80 Ra	6400 lm	50 W	Direct
50703	>80 Ra	8000 lm	64 W	Direct
50704	>80 Ra	4800 lm	38 W	Indirect/Direct
50705	>80 Ra	6000 lm	48 W	Indirect/Direct
50706	>80 Ra	9600 lm	76 W	Indirect/Direct
50707	>80 Ra	12000 lm	96 W	Indirect/Direct

